



BESCHREIBUNG UND FUNKTION

Unsere Poly-V Keilrippenriemenscheiben werden analog zum internationalen Standard ISO 9982 / DIN 7867 produziert.

WERKSTOFF

Grauguss EN-GJL-200 (G20 – UNI 5007)

OBERFLÄCHENBEHANDLUNG UND WUCHTUNG

Die Oberfläche von allen Standard-Poly-V-Keilrippenriemenscheiben sind durch phosphatieren geschützt. Alle Scheiben sind statisch ausgewuchtet und können für periphere Anwendung bis zu einer Geschwindigkeit von 30 m/sec verwendet werden.



Berechnung der Umfangsgeschwindigkeit (Vp)

$$V_p = \frac{\pi \cdot d_p \cdot n}{60 \cdot 1000} = \frac{d_p \cdot n}{19100} = \text{m/sec}$$

d_p = Durchmesser in mm
 n = Umdrehung pro Minute
 V_p = Geschwindigkeit in m/s

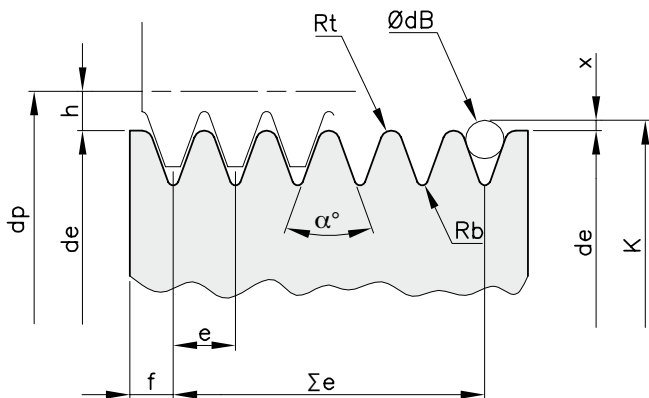

Abmessungen Scheiben

Profil		J	L
Rillenabstand - e	(mm)	2,34 ± 0,03	4,70 ± 0,05
Rollenwinkel	(α°)	40° ± 0,5	40° ± 0,5
Rt min	(mm)	0,20	0,40
Rb max	(mm)	0,40	0,40
Σ e	(mm)	$e \times (z - 1) \pm 0,3$	$e \times (z - 1) \pm 0,3$
ØdB Durchmesser	(mm)	1,50 ± 0,01	3,50 ± 0,01
2 X	(mm)	0,23	2,36
h	(mm)	1,20	3,00
dp	(mm)	$d_e + (2 \cdot h)$	$d_e + (2 \cdot h)$
f min	(mm)	1,80	3,30
f real (mm)	8 Rillen	3,31	7,55
	12 Rillen	3,38	7,65
	16 Rillen	3,45	7,75

Ausführung J 8 Rillen

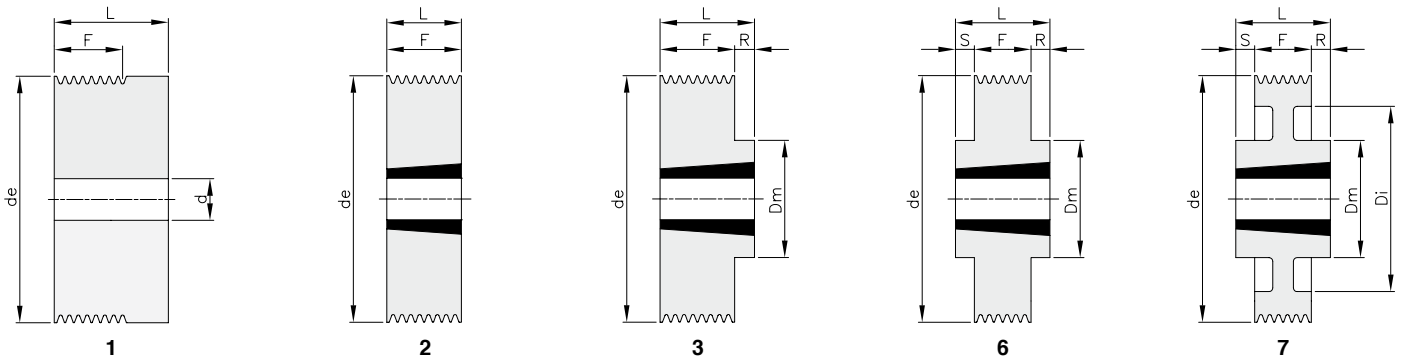

Werkstoff: Grauguss EN-GJL-200

Beschreibung	Artikelnr.	Rillen	de	Typ	Spann- buchsen	Bohrung max.	Dm	Di	F	L	R	S	d	kg
J 40 08	PJ08040	8	40	1					19,7	32			12	0,24
J 45 08	PJ08045	8	45	1					19,7	32			12	0,32
J 50 08	PJ08050	8	50	1					19,7	32			12	0,40
J 56 08	PJ08056	8	56	2	1108	28			23	23				0,20
J 63 08	PJ08063	8	63	2	1108	28			23	23				0,30
J 71 08	PJ08071	8	71	2	1108	28			23	23				0,44
J 75 08	PJ08075	8	75	2	1108	28			23	23				0,52
J 80 08	PJ08080	8	80	3	1610	42	70		23	26	3			0,41
J 85 08	PJ08085	8	85	3	1610	42	70		23	26	3			0,51
J 90 08	PJ08090	8	90	3	1610	42	70		23	26	3			0,62
J 95 08	PJ08095	8	95	3	1610	42	82		23	26	3			0,78
J 100 08	PJ08100	8	100	3	1610	42	82		23	26	3			0,90
J 106 08	PJ08106	8	106	3	1610	42	82		23	26	3			1,05
J 112 08	PJ08112	8	112	3	1610	42	90		23	26	3			1,25
J 118 08	PJ08118	8	118	3	1610	42	90		23	26	3			1,43
J 125 08	PJ08125	8	125	3	1610	42	90		23	26	3			1,64
J 132 08	PJ08132	8	132	3	1610	42	90		23	26	3			1,88
J 140 08	PJ08140	8	140	3	1610	42	90		23	26	3			2,16
J 160 08	PJ08160	8	160	6	2012	50	110		23	32	4,5	4,5		3,01
J 180 08	PJ08180	8	180	6	2012	50	110		23	32	4,5	4,5		3,92
J 190 08	PJ08190	8	190	6	2012	50	110		23	32	4,5	4,5		4,38
J 200 08	PJ08200	8	200	6	2012	50	110		23	32	4,5	4,5		4,88
J 212 08	PJ08212	8	212	6	2012	50	110		23	32	4,5	4,5		5,49
J 224 08	PJ08224	8	224	6	2012	50	110		23	32	4,5	4,5		6,17
J 250 08	PJ08250	8	250	6	2012	50	110		23	32	4,5	4,5		7,73
J 280 08	PJ08280	8	280	7	2012	50	110	260	23	32	4,5	4,5		5,78
J 315 08	PJ08315	8	315	7	2012	50	110	295	23	32	4,5	4,5		6,92

Ausführung J 12 Rillen

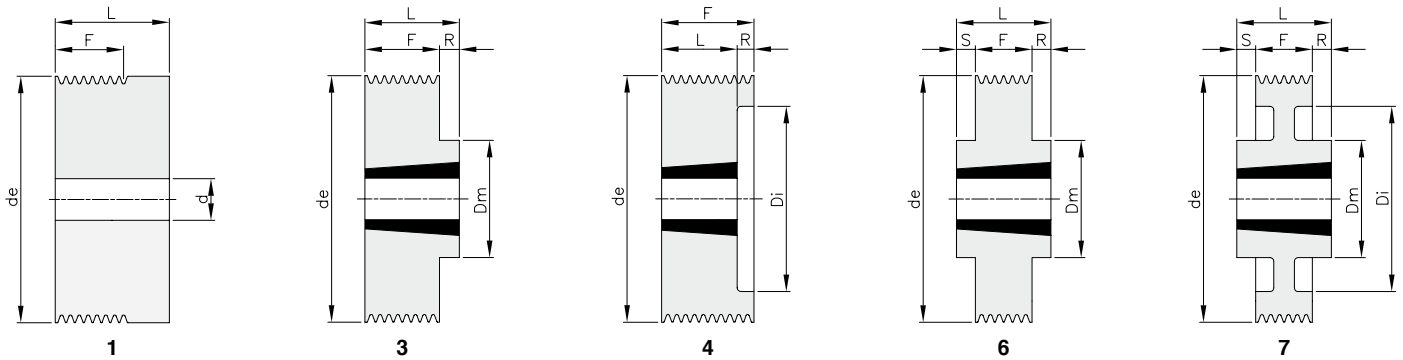

Werkstoff: Grauguss EN-GJL-200

Beschreibung	Artikelnr.	Rillen	de	Typ	Spann- buchsen	Bohrung max.	Dm	Di	F	L	R	S	d	kg
J 40 12	PJ12040	12	40	1					29,1	41,5			12	0,31
J 45 12	PJ12045	12	45	1					29,1	41,5			12	0,41
J 50 12	PJ12050	12	50	1					29,1	41,5			12	0,52
J 56 12	PJ12056	12	56	4	1108	28	40		32,5	23	9,50			0,28
J 63 12	PJ12063	12	63	4	1108	28	46		32,5	23	9,50			0,39
J 71 12	PJ12071	12	71	4	1108	28	46		32,5	23	9,50			0,57
J 75 12	PJ12075	12	75	4	1610	42	60		32,5	26	6,50			0,38
J 80 12	PJ12080	12	80	4	1610	42	60		32,5	26	6,50			0,52
J 85 12	PJ12085	12	85	4	1610	42	60		32,5	26	6,50			0,66
J 90 12	PJ12090	12	90	4	1610	42	74		32,5	26	6,50			0,76
J 95 12	PJ12095	12	95	4	1610	42	74		32,5	26	6,50			0,93
J 100 12	PJ12100	12	100	4	1610	42	74		32,5	26	6,50			1,10
J 106 12	PJ12106	12	106	4	1610	42	88		32,5	26	6,50			1,24
J 112 12	PJ12112	12	112	4	1610	42	88		32,5	26	6,50			1,47
J 118 12	PJ12118	12	118	4	2012	50	98		32,5	32	0,50			1,55
J 125 12	PJ12125	12	125	4	2012	50	98		32,5	32	0,50			1,90
J 132 12	PJ12132	12	132	4	2012	50	98		32,5	32	0,50			2,21
J 140 12	PJ12140	12	140	3	2517	65	120		32,5	45	12,50			2,71
J 160 12	PJ12160	12	160	3	2517	65	120		32,5	45	12,50			3,80
J 180 12	PJ12180	12	180	6	2517	65	120		32,5	45	6,25	6,25		5,03
J 190 12	PJ12190	12	190	6	2517	65	120		32,5	45	6,25	6,25		5,72
J 200 12	PJ12200	12	200	6	2517	65	120		32,5	45	6,25	6,25		6,40
J 212 12	PJ12212	12	212	6	2517	65	120		32,5	45	6,25	6,25		7,33
J 224 12	PJ12224	12	224	6	2517	65	120		32,5	45	6,25	6,25		8,29
J 250 12	PJ12250	12	250	6	2517	65	120		32,5	45	6,25	6,25		10,47
J 280 12	PJ12280	12	280	7	2517	65	120	260	32,5	45	6,25	6,25		7,38
J 315 12	PJ12315	12	315	7	2517	65	120	295	32,5	45	6,25	6,25		8,99

Ausführung J 16 Rillen

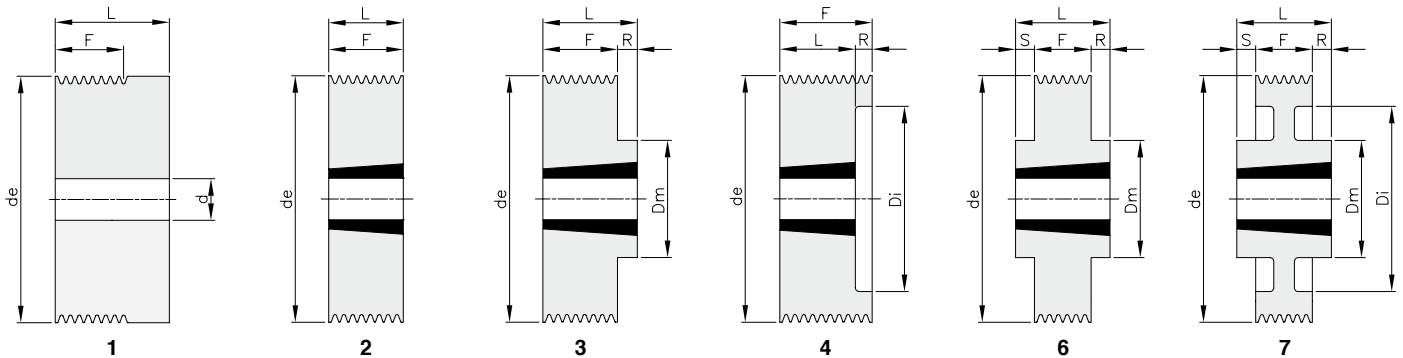

Werkstoff: Grauguss EN-GJL-200

Beschreibung	Artikelnr.	Rillen	de	Typ	Spann- buchsen	Bohrung max.	Dm	Di	F	L	R	S	d	kg
J 40 16	PJ16040	16	40	1					38,5	51			12	0,38
J 45 16	PJ16045	16	45	1					38,5	51			12	0,50
J 50 16	PJ16050	16	50	1					38,5	51			12	0,63
J 56 16	PJ16056	16	56	1					38,5	51			12	0,81
J 63 16	PJ16063	16	63	1					38,5	51			12	1,05
J 71 16	PJ16071	16	71	2	1215	32	55		42	42				0,63
J 75 16	PJ16075	16	75	4	1610	42	60		42	26	16			0,46
J 80 16	PJ16080	16	80	4	1610	42	60		42	26	16			0,64
J 85 16	PJ16085	16	85	4	1610	42	60		42	26	16			0,84
J 90 16	PJ16090	16	90	4	1610	42	74		42	26	16			0,87
J 95 16	PJ16095	16	95	4	1610	42	74		42	26	16			1,08
J 100 16	PJ16100	16	100	4	1610	42	74		42	26	16			1,32
J 106 16	PJ16106	16	106	4	1610	42	88		42	26	16			1,40
J 112 16	PJ16112	16	112	4	1610	42	88		42	26	16			1,70
J 118 16	PJ16118	16	118	4	2012	50	98		42	32	10			1,79
J 125 16	PJ16125	16	125	4	2012	50	98		42	32	10			2,18
J 132 16	PJ16132	16	132	4	2012	50	98		42	32	10			2,60
J 140 16	PJ16140	16	140	3	2517	65	120		42	45	3			2,96
J 160 16	PJ16160	16	160	3	2517	65	120		42	45	3			4,37
J 180 16	PJ16180	16	180	6	2517	65	120		42	45	1,5	1,5		5,97
J 190 16	PJ16190	16	190	6	2517	65	120		42	45	1,5	1,5		6,85
J 200 16	PJ16200	16	200	6	2517	65	120		42	45	1,5	1,5		7,75
J 212 16	PJ16212	16	212	6	2517	65	120		42	45	1,5	1,5		8,90
J 224 16	PJ16224	16	224	6	2517	65	120		42	45	1,5	1,5		10,10
J 250 16	PJ16250	16	250	6	2517	65	120		42	45	1,5	1,5		13,00
J 280 16	PJ16280	16	280	7	2517	65	120	260	42	45	1,5	1,5		8,38
J 315 16	PJ16315	16	315	7	2517	65	120	295	42	45	1,5	1,5		9,57

Ausführung L 8 Rillen

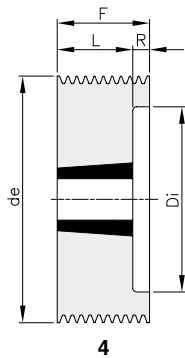

4

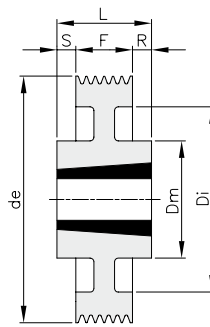

7

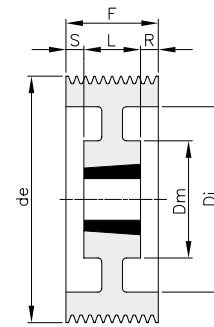

8

Werkstoff: Grauguss EN-GJL-200

Beschreibung	Artikelnr.	Rillen	de	Typ	Spannbuchsen	Bohrung max.	Dm	Di	F	L	R	S	d	kg
L 75 08	PL08075	8	75	4	1210	32		56	48	26	22			0,66
L 80 08	PL08080	8	80	4	1210	32		56	48	26	22			0,86
L 85 08	PL08085	8	85	4	1210	32		61	48	26	22			1,00
L 90 08	PL08090	8	90	4	1610	42		66	48	26	22			1,01
L 95 08	PL08095	8	95	4	1610	42		71	48	26	22			1,16
L 100 08	PL08100	8	100	4	1610	42		76	48	26	22			1,31
L 106 08	PL08106	8	106	4	1610	42		82	48	26	22			1,53
L 112 08	PL08112	8	112	4	1610	42		88	48	26	22			1,75
L 118 08	PL08118	8	118	4	2012	50		94	48	32	16			1,88
L 125 08	PL08125	8	125	4	2012	50		101	48	32	16			2,22
L 132 08	PL08132	8	132	4	2012	50		108	48	32	16			2,54
L 140 08	PL08140	8	140	4	2517	65		116	48	45	3			3,02
L 150 08	PL08150	8	150	4	2517	65		126	48	45	3			3,75
L 160 08	PL08160	8	160	4	2517	65		136	48	45	3			4,54
L 170 08	PL08170	8	170	4	2517	65		146	48	45	3			4,35
L 180 08	PL08180	8	180	8	2517	65	120	156	48	45	1,5	1,5		4,52
L 190 08	PL08190	8	190	8	2517	65	120	166	48	45	1,5	1,5		4,72
L 200 08	PL08200	8	200	8	2517	65	120	176	48	45	1,5	1,5		5,07
L 212 08	PL08212	8	212	8	2517	65	120	188	48	45	1,5	1,5		5,50
L 224 08	PL08224	8	224	8	2517	65	120	202	48	45	1,5	1,5		5,77
L 250 08	PL08250	8	250	7	3020	75	146	228	48	52	2	2		7,39
L 280 08	PL08280	8	280	7	3020	75	146	256	48	52	2	2		8,90
L 315 08	PL08315	8	315	7	3020	75	146	285	48	52	2	2		11,30

Ausführung L 12 Rillen

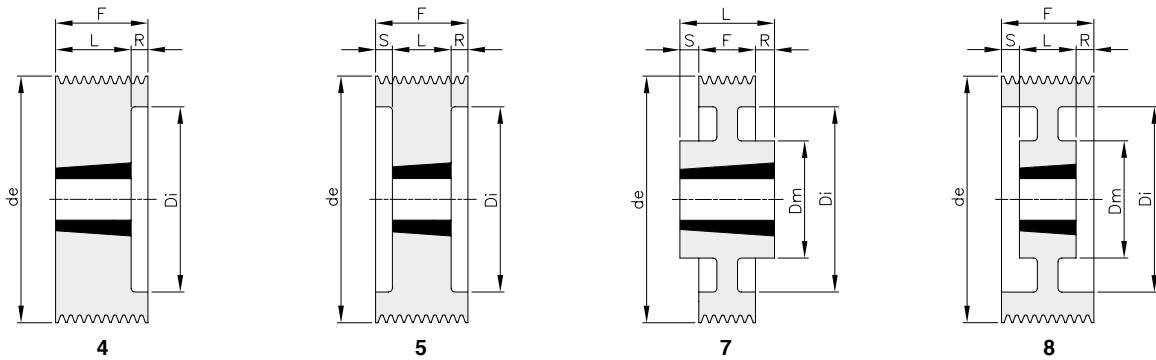

Werkstoff: Grauguss EN-GJL-200

Beschreibung	Artikelnr.	Rillen	de	Typ	Spann- buchsen	Bohrung max.	Dm	Di	F	L	R	S	d	kg
L 75 12	PL12075	12	75	4	1215	32		56	67	42	25			0,97
L 80 12	PL12080	12	80	4	1215	32		56	67	42	25			1,25
L 85 12	PL12085	12	85	4	1215	32		61	67	42	25			1,47
L 90 12	PL12090	12	90	4	1615	42		66	67	42	25			1,45
L 95 12	PL12095	12	95	4	1615	42		71	67	42	25			1,71
L 100 12	PL12100	12	100	4	2012	50		79	67	32	35			1,39
L 106 12	PL12106	12	106	4	2012	50		82	67	32	35			1,73
L 112 12	PL12112	12	112	4	2012	50		88	67	32	35			2,02
L 118 12	PL12118	12	118	5	2517	65		97	67	45	11	11		1,96
L 125 12	PL12125	12	125	5	2517	65		101	67	45	11	11		2,46
L 132 12	PL12132	12	132	5	2517	65		108	67	45	11	11		2,97
L 140 12	PL12140	12	140	5	2517	65		116	67	45	11	11		3,55
L 150 12	PL12150	12	150	5	2517	65		126	67	45	11	11		4,30
L 160 12	PL12160	12	160	5	2517	65		136	67	45	11	11		5,12
L 170 12	PL12170	12	170	5	2517	65		146	67	45	11	11		6,03
L 180 12	PL12180	12	180	8	2517	65	120	156	67	45	11	11		5,34
L 190 12	PL12190	12	190	8	2517	65	120	166	67	45	11	11		5,60
L 200 12	PL12200	12	200	8	3020	75	146	176	67	52	7,5	7,5		6,99
L 212 12	PL12212	12	212	8	3020	75	146	188	67	52	7,5	7,5		7,06
L 224 12	PL12224	12	224	8	3020	75	146	202	67	52	7,5	7,5		7,41
L 250 12	PL12250	12	250	8	3020	75	146	228	67	52	7,5	7,5		8,67
L 280 12	PL12280	12	280	8	3020	75	146	256	67	52	7,5	7,5		10,58
L 315 12	PL12315	12	315	7	3535	90	178	285	67	89	11	11		18,23

Ausführung L 16 Rillen

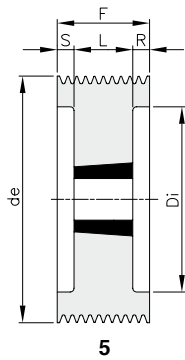

5

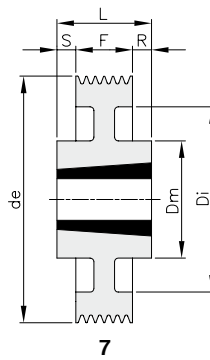

7

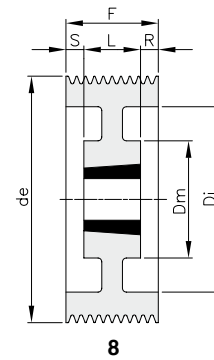

8

Werkstoff: Grauguss EN-GJL-200

Beschreibung	Artikelnr.	Rillen	de	Typ	Spannbuchsen	Bohrung max.	Dm	Di	F	L	R	S	d	kg
L 85 16	PL16085	16	85	5	1215	32		61	86	42	22	22		1,76
L 90 16	PL16090	16	90	5	1615	42		66	86	42	22	22		1,78
L 95 16	PL16095	16	95	5	1615	42		71	86	42	22	22		2,02
L 100 16	PL16100	16	100	5	2012	50		79	86	32	27	27		1,69
L 106 16	PL16106	16	106	5	2012	50		82	86	32	27	27		2,12
L 112 16	PL16112	16	112	5	2012	50		88	86	32	27	27		2,42
L 118 16	PL16118	16	118	5	2517	65		97	86	45	20,5	20,5		2,31
L 125 16	PL16125	16	125	5	2517	65		101	86	45	20,5	20,5		2,92
L 132 16	PL16132	16	132	5	2517	65		108	86	45	20,5	20,5		3,44
L 140 16	PL16140	16	140	5	2517	65		116	86	45	20,5	20,5		4,05
L 150 16	PL16150	16	150	5	2517	65		126	86	45	20,5	20,5		4,85
L 160 16	PL16160	16	160	5	3020	75		136	86	52	17	17		4,88
L 170 16	PL16170	16	170	5	3020	75		146	86	52	17	17		5,96
L 180 16	PL16180	16	180	5	3020	75		156	86	52	17	17		7,09
L 190 16	PL16190	16	190	8	3020	75	146	166	86	52	17	17		8,20
L 200 16	PL16200	16	200	8	3020	75	146	176	86	52	17	17		7,92
L 212 16	PL16212	16	212	8	3020	75	146	188	86	52	17	17		8,03
L 224 16	PL16224	16	224	8	3020	75	146	202	86	52	17	17		8,42
L 250 16	PL16250	16	250	7	3535	90	178	228	86	89	1,5	1,5		16,09
L 280 16	PL16280	16	280	7	3535	90	178	256	86	89	1,5	1,5		17,10
L 315 16	PL16315	16	315	7	3535	90	178	285	86	89	1,5	1,5		20,93