

Werkstoff: Neopren mit Fiberglaseinlagen

ABMESSUNGEN UND TOLERANZEN DER DICKE

Typ	Teilung mm	hs mm	Tol. mm	ht mm	S mm	β Grad
XL	5,080	2,3	± 0,20	1,27	2,57	50
L	9,525	3,6	± 0,25	1,91	4,65	40
H	12,700	4,3	± 0,25	2,29	6,12	40
XH	22,225	11,2	± 0,65	6,35	12,57	40

BREITENTOLERANZEN

Nennlänge		Breitentoleranz auf Teilungslänge		
		bis 838,2	> 838,2 bis 1676,4	> 1676,4
in 1/100 eines Zolls	in mm	mm	mm	mm
0,12–0,37	3,0–9,5	+ 0,5 - 0,8	–	–
> 037–150	> 9,5–38,1	+ 0,8 - 0,8	+ 0,8 - 1,3	+ 0,8 - 1,3
> 150–200	> 38,1–50,8	+ 0,8 - 1,3	+ 1,3 - 1,3	+ 1,3 - 1,5
> 200–300	> 50,8–76,2	+ 1,3 - 1,5	+ 1,5 - 1,5	+ 1,5 - 2,0

AUSWAHLTABELLE RIEMENTEILUNG

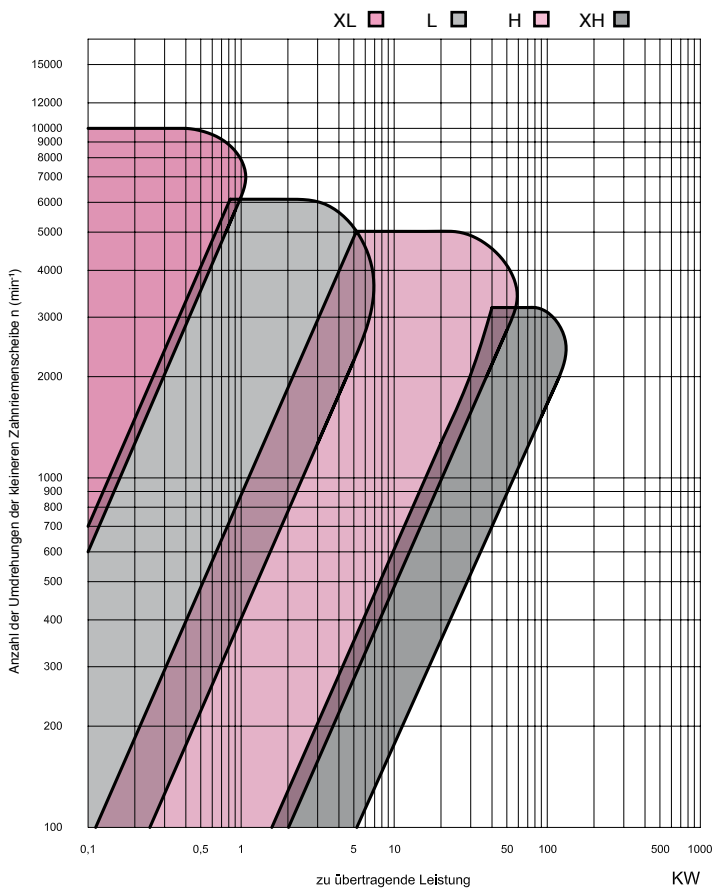

LÄNGENTOLERANZEN

Wirklänge		Toleranz
in 1/10 eines Zolls	in mm	mm
< 36	< 91,4	± 0,15
> 36–100	> 91,4–254,0	± 0,20
> 100–150	> 254,0–381,0	± 0,23
> 150–200	> 381,0–508,0	± 0,25
> 200–300	> 508,0–762,0	± 0,30
> 300–390	> 762,0–990,6	± 0,33
> 390–480	> 990,6–1219,2	± 0,38
> 480–600	> 1219,2–1524,0	± 0,40
> 600–700	> 1524,0–1778,0	± 0,43
> 700–800	> 1778,0–2032,0	± 0,45
> 800–900	> 2032,0–2286,0	± 0,48
> 900–1000	> 2286,0–2540,0	± 0,50
> 1000–1100	> 2540,0–2794,0	± 0,53
> 1100–1200	> 2794,0–3048,0	± 0,55
> 1200–1260	> 3048,0–3200,4	± 0,58
> 1260–1400	> 3200,4–3556,0	± 0,60
> 1400–1600	> 3556,0–4064,0	± 0,65
> 1600–1700	> 4064,0–4318,0	± 0,68
> 1700–1800	> 4318,0–4572,0	± 0,70



ZAHNRIEMEN ZOLL – ISO 5296

MXL

Teilung 0,080 (2,032 mm)

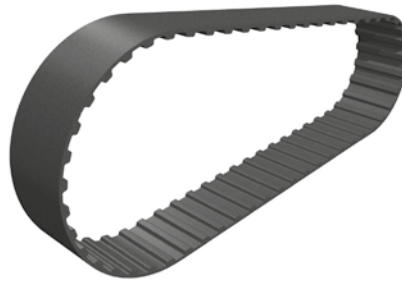

Werkstoff: Neopren

Beschreibung		Zähne- zahl	Nennlänge		Artikelnr. MXL 012 Breite 3,05 mm	Artikelnr. MXL 019 Breite 4,83 mm	Artikelnr. MXL 025 Breite 6,35 mm
			Zoll	mm			
44	MXL	55	4,40	111,76	1120120440	1120190440	1120250440
44,8	MXL	56	4,48	113,79	1120120448	1120190448	1120250448
46,4	MXL	58	4,64	117,86	1120120464	1120190464	1120250464
48	MXL	60	4,80	121,92	1120120480	1120190480	1120250480
48,8	MXL	61	4,88	123,95	1120120488	1120190488	1120250488
50,4	MXL	63	5,04	128,02	1120120504	1120190504	1120250504
53,6	MXL	67	5,36	136,14	1120120536	1120190536	1120250536
54,4	MXL	68	5,44	138,18	1120120544	1120190544	1120250544
56	MXL	70	5,60	142,24	1120120560	1120190560	1120250560
56,8	MXL	71	5,68	144,27	1120120568	1120190568	1120250568
57,6	MXL	72	5,76	146,30	1120120576	1120190576	1120250576
60	MXL	75	6,00	152,40	1120120600	1120190600	1120250600
61,6	MXL	77	6,16	156,46	1120120616	1120190616	1120250616
64	MXL	80	6,40	162,56	1120120640	1120190640	1120250640
65,6	MXL	82	6,56	166,62	1120120656	1120190656	1120250656
67,2	MXL	84	6,72	170,69	1120120672	1120190672	1120250672
69,6	MXL	87	6,96	176,78	1120120696	1120190696	1120250696
70,4	MXL	88	7,04	178,82	1120120704	1120190704	1120250704
72	MXL	90	7,20	182,88	1120120720	1120190720	1120250720
75,2	MXL	94	7,52	191,01	1120120752	1120190752	1120250752
76	MXL	95	7,60	193,04	1120120760	1120190760	1120250760
77,6	MXL	97	7,76	197,10	1120120776	1120190776	1120250776
80	MXL	100	8,00	203,20	1120120800	1120190800	1120250800
80,8	MXL	101	8,08	205,23	1120120808	1120190808	1120250808
82,4	MXL	103	8,24	209,30	1120120824	1120190824	1120250824
84,8	MXL	106	8,48	215,39	1120120848	1120190848	1120250848
88	MXL	110	8,80	223,52	1120120880	1120190880	1120250880
89,6	MXL	112	8,96	227,58	1120120896	1120190896	1120250896
90,4	MXL	113	9,04	229,62	1120120904	1120190904	1120250904
91,2	MXL	114	9,12	231,65	1120120912	1120190912	1120250912
94,4	MXL	118	9,44	239,78	1120120944	1120190944	1120250944
96	MXL	120	9,60	243,84	1120120960	1120190960	1120250960
97,6	MXL	122	9,76	247,90	1120120976	1120190976	1120250976
98,4	MXL	123	9,84	249,94	1120120984	1120190984	1120250984
100	MXL	125	10,00	254,00	1120121000	1120191000	1120251000
100,8	MXL	126	10,08	256,03	1120121008	1120191008	1120251008
105,6	MXL	132	10,56	268,22	1120121056	1120191056	1120251056
112	MXL	140	11,20	284,48	1120121120	1120191120	1120251120
120	MXL	150	12,00	304,80	1120121200	1120191200	1120251200
124	MXL	155	12,40	314,96	1120121240	1120191240	1120251240
131,2	MXL	164	13,12	333,25	1120121312	1120191312	1120251312



ZAHNRIEMEN ZOLL – ISO 5296

MXL

Teilung 0,080 (2,032 mm)

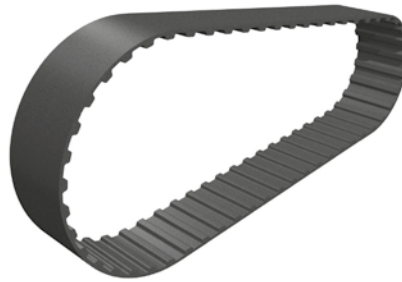

Werkstoff: Neopren

Beschreibung	Zähne- zahl	Nennlänge		Artikelnr. MXL 012 Breite 3,05 mm	Artikelnr. MXL 019 Breite 4,83 mm	Artikelnr. MXL 025 Breite 6,35 mm
		Zoll	mm			
132,8 MXL	166	13,28	337,31	1120121328	1120191328	1120251328
136 MXL	170	13,60	345,44	1120121360	1120191360	1120251360
140 MXL	175	14,00	355,60	1120121400	1120191400	1120251400
144 MXL	180	14,40	365,76	1120121440	1120191440	1120251440
147,2 MXL	184	14,72	373,89	1120121472	1120191472	1120251472
238,4 MXL	298	23,84	605,54	1120122384	1120192384	1120252384
277,6 MXL	347	27,76	705,10	1120122776	1120192776	1120252776
320 MXL	400	32,00	812,80	1120123200	1120193200	1120253200
329,6 MXL	412	32,96	837,18	1120123296	1120193296	1120253296



ZAHNRIEMEN ZOLL – ISO 5296

XL

Teilung 1/5" (5,080 mm)

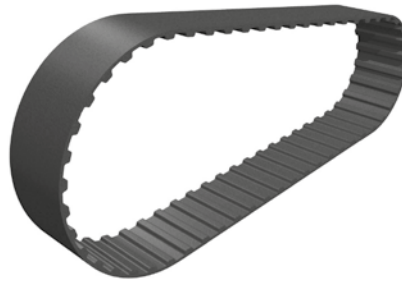

Werkstoff: Neopren

Beschreibung	Zähnezahl	Nennlänge		Artikelnr. XL 025 Breite 6,35 mm	Artikelnr. XL 031 Breite 7,87 mm	Artikelnr. XL 037 Breite 9,40 mm
		Zoll	mm			
60 XL	30	6,00	152,40	1130250060	1130310060	1130370060
*70 XL	35	7,00	177,80	1130250070	1130310070	1130370070
76 XL	38	7,60	193,04	1130250076	1130310076	1130370076
80 XL	40	8,00	203,20	1130250080	1130310080	1130370080
88 XL	44	8,80	223,52	1130250088	1130310088	1130370088
90 XL	45	9,00	228,60	1130250090	1130310090	1130370090
96 XL	48	9,60	243,84	1130250096	1130310096	1130370096
98 XL	49	9,80	248,92	1130250098	1130310098	1130370098
100 XL	50	10,00	254,00	1130250100	1130310100	1130370100
102 XL	51	10,20	259,08	1130250102	1130310102	1130370102
106 XL	53	10,60	269,24	1130250106	1130310106	1130370106
108 XL	54	10,80	274,32	1130250108	1130310108	1130370108
110 XL	55	11,00	279,40	1130250110	1130310110	1130370110
114 XL	57	11,40	289,56	1130250114	1130310114	1130370114
116 XL	58	11,60	294,64	1130250116	1130310116	1130370116
120 XL	60	12,00	304,80	1130250120	1130310120	1130370120
130 XL	65	13,00	330,20	1130250130	1130310130	1130370130
134 XL	67	13,40	340,36	1130250134	1130310134	1130370134
136 XL	68	13,60	345,44	1130250136	1130310136	1130370136
138 XL	69	13,80	350,52	1130250138	1130310138	1130370138
140 XL	70	14,00	355,60	1130250140	1130310140	1130370140
142 XL	71	14,20	360,68	1130250142	1130310142	1130370142
148 XL	74	14,80	375,92	1130250148	1130310148	1130370148
150 XL	75	15,00	381,00	1130250150	1130310150	1130370150
156 XL	78	15,60	396,24	1130250156	1130310156	1130370156
160 XL	80	16,00	406,40	1130250160	1130310160	1130370160
166 XL	83	16,60	421,64	1130250166	1130310166	1130370166
170 XL	85	17,00	431,80	1130250170	1130310170	1130370170
176 XL	88	17,60	447,04	1130250176	1130310176	1130370176
180 XL	90	18,00	457,20	1130250180	1130310180	1130370180
190 XL	95	19,00	482,60	1130250190	1130310190	1130370190
194 XL	97	19,40	492,76	1130250194	1130310194	1130370194
196 XL	98	19,60	497,84	1130250196	1130310196	1130370196
198 XL	99	19,80	502,92	1130250198	1130310198	1130370198
200 XL	100	20,00	508,00	1130250200	1130310200	1130370200
210 XL	105	21,00	533,40	1130250210	1130310210	1130370210
220 XL	110	22,00	558,80	1130250220	1130310220	1130370220
*228 XL	114	22,80	579,12	1130250228	1130310228	1130370228
230 XL	115	23,00	584,20	1130250230	1130310230	1130370230
*234 XL	117	23,40	594,36	1130250234	1130310234	1130370234
240 XL	120	24,00	609,60	1130250240	1130310240	1130370240



ZAHNRIEMEN ZOLL – ISO 5296

XL

Teilung 1/5" (5,080 mm)

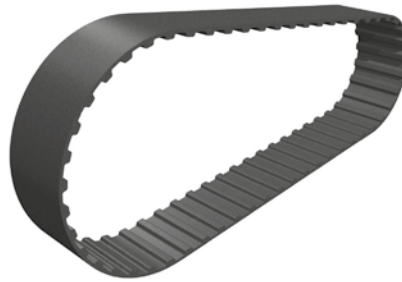

Werkstoff: Neopren

Beschreibung	Zähne- zahl	Nennlänge		Artikelnr. XL 025 Breite 6,35 mm	Artikelnr. XL 031 Breite 7,87 mm	Artikelnr. XL 037 Breite 9,40 mm
		Zoll	mm			
244 XL	122	24,40	619,76	1130250244	1130310244	1130370244
248 XL	124	24,80	629,92	1130250248	1130310248	1130370248
250 XL	125	25,00	635,00	1130250250	1130310250	1130370250
260 XL	130	26,00	660,40	1130250260	1130310260	1130370260
270 XL	135	27,00	685,80	1130250270	1130310270	1130370270
272 XL	136	27,20	690,88	1130250272	1130310272	1130370272
280 XL	140	28,00	711,20	1130250280	1130310280	1130370280
290 XL	145	29,00	736,60	1130250290	1130310290	1130370290
296 XL	148	29,60	751,84	1130250296	1130310296	1130370296
300 XL	150	30,00	762,00	1130250300	1130310300	1130370300
310 XL	155	31,00	787,40	1130250310	1130310310	1130370310
316 XL	158	31,60	802,64	1130250316	1130310316	1130370316
320 XL	160	32,00	812,80	1130250320	1130310320	1130370320
322 XL	161	32,20	817,88	1130250322	1130310322	1130370322
330 XL	165	33,00	838,20	1130250330	1130310330	1130370330
340 XL	170	34,00	863,60	1130250340	1130310340	1130370340
344 XL	172	34,40	873,76	1130250344	1130310344	1130370344
360 XL	180	36,00	914,40	1130250360	1130310360	1130370360
380 XL	190	38,00	965,20	1130250380	1130310380	1130370380
390 XL	195	39,00	990,60	1130250390	1130310390	1130370390
*392 XL	196	39,20	995,68	1130250392	1130310392	1130370392
412 XL	206	41,20	1046,48	1130250412	1130310412	1130370412
414 XL	207	41,40	1051,56	1130250414	1130310414	1130370414
432 XL	216	43,20	1097,28	1130250432	1130310432	1130370432
434 XL	217	43,40	1102,36	1130250434	1130310434	1130370434
630 XL	315	63,00	1600,20	1130250630	1130310630	1130370630
730 XL	365	73,00	1854,20	1130250730	1130310730	1130370730



ZAHNRIEMEN ZOLL – ISO 5296

L

Teilung 3/8" (9,525 mm)

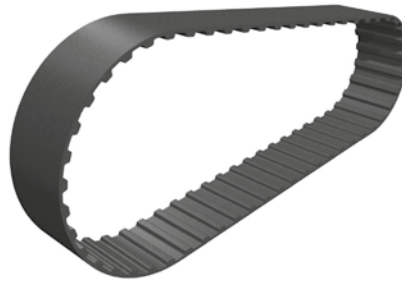

Werkstoff: Neopren

Beschreibung	Zähne- zahl	Nennlänge Zoll	Nennlänge mm	Artikelnr. L 050 Breite 12,70 mm	Artikelnr. L 075 Breite 19,05 mm	Artikelnr. L 100 Breite 25,40 mm
124 L	33	12,40	314,96	1140500124	1140750124	1141000124
150 L	40	15,00	381,00	1140500150	1140750150	1141000150
173 L	46	17,30	439,42	1140500173	1140750173	1141000173
187 L	50	18,70	474,98	1140500187	1140750187	1141000187
210 L	56	21,00	533,40	1140500210	1140750210	1141000210
225 L	60	22,50	571,50	1140500225	1140750225	1141000225
236 L	63	23,60	599,44	1140500236	1140750236	1141000236
240 L	64	24,00	609,60	1140500240	1140750240	1141000240
244 L	65	24,40	619,76	1140500244	1140750244	1141000244
255 L	68	25,50	647,70	1140500255	1140750255	1141000255
270 L	72	27,00	685,80	1140500270	1140750270	1141000270
285 L	76	28,50	723,90	1140500285	1140750285	1141000285
300 L	80	30,00	762,00	1140500300	1140750300	1141000300
322 L	86	32,20	817,88	1140500322	1140750322	1141000322
345 L	92	34,50	876,30	1140500345	1140750345	1141000345
367 L	98	36,70	932,18	1140500367	1140750367	1141000367
390 L	104	39,00	990,60	1140500390	1140750390	1141000390
405 L	108	40,50	1028,70	1140500405	1140750405	1141000405
420 L	112	42,00	1066,80	1140500420	1140750420	1141000420
450 L	120	45,00	1143,00	1140500450	1140750450	1141000450
480 L	128	48,00	1219,20	1140500480	1140750480	1141000480
510 L	136	51,00	1295,40	1140500510	1140750510	1141000510
540 L	144	54,00	1371,60	1140500540	1140750540	1141000540
600 L	160	60,00	1524,00	1140500600	1140750600	1141000600
817 L	218	81,70	2075,18	1140500817	1140750817	1141000817



ZAHNRIEMEN ZOLL – ISO 5296

H

Teilung 1/2" (12,700 mm)

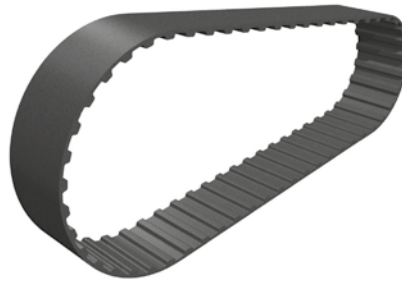

Werkstoff: Neopren

Beschreibung	Zähnezahl	Nennlänge Zoll	Nennlänge mm	Artikelnr. H 075 Breite 19,50 mm	Artikelnr. H 100 Breite 25,40 mm	Artikelnr. H 150 Breite 38,10 mm	Artikelnr. H 200 Breite 50,80 mm	Artikelnr. H 300 Breite 76,20 mm
240 H	48	24,00	609,60	1150750240	1151000240	1151500240	1152000240	1153000240
255 H	51	25,50	647,70	1150750255	1151000255	1151500255	1152000255	1153000255
270 H	54	27,00	685,80	1150750270	1151000270	1151500270	1152000270	1153000270
300 H	60	30,00	762,00	1150750300	1151000300	1151500300	1152000300	1153000300
330 H	66	33,00	838,20	1150750330	1151000330	1151500330	1152000330	1153000330
360 H	72	36,00	914,40	1150750360	1151000360	1151500360	1152000360	1153000360
370 H	74	37,00	939,80	1150750370	1151000370	1151500370	1152000370	1153000370
390 H	78	39,00	990,60	1150750390	1151000390	1151500390	1152000390	1153000390
420 H	84	42,00	1066,80	1150750420	1151000420	1151500420	1152000420	1153000420
450 H	90	45,00	1143,00	1150750450	1151000450	1151500450	1152000450	1153000450
480 H	96	48,00	1219,20	1150750480	1151000480	1151500480	1152000480	1153000480
510 H	102	51,00	1295,40	1150750510	1151000510	1151500510	1152000510	1153000510
540 H	108	54,00	1371,60	1150750540	1151000540	1151500540	1152000540	1153000540
570 H	114	57,00	1447,80	1150750570	1151000570	1151500570	1152000570	1153000570
600 H	120	60,00	1524,00	1150750600	1151000600	1151500600	1152000600	1153000600
630 H	126	63,00	1600,20	1150750630	1151000630	1151500630	1152000630	1153000630
660 H	132	66,00	1676,40	1150750660	1151000660	1151500660	1152000660	1153000660
670 H	134	67,00	1701,80	1150750670	1151000670	1151500670	1152000670	1153000670
700 H	140	70,00	1778,00	1150750700	1151000700	1151500700	1152000700	1153000700
730 H	146	73,00	1854,20	1150750730	1151000730	1151500730	1152000730	1153000730
750 H	150	75,00	1905,00	1150750750	1151000750	1151500750	1152000750	1153000750
800 H	160	80,00	2032,00	1150750800	1151000800	1151500800	1152000800	1153000800
850 H	170	85,00	2159,00	1150750850	1151000850	1151500850	1152000850	1153000850
900 H	180	90,00	2286,00	1150750900	1151000900	1151500900	1152000900	1153000900
1000 H	200	100,00	2540,00	1150751000	1151001000	1151501000	1152001000	1153001000
1100 H	220	110,00	2794,00	1150751100	1151001100	1151501100	1152001100	1153001100
1120 H	224	112,00	2844,80	1150751120	1151001120	1151501120	1152001120	1153001120
1140 H	228	114,00	2895,60	1150751140	1151001140	1151501140	1152001140	1153001140
1250 H	250	125,00	3175,00	1150751250	1151001250	1151501250	1152001250	1153001250
1400 H	280	140,00	3556,00	1150751400	1151001400	1151501400	1152001400	1153001400
1700 H	340	170,00	4318,00	1150751700	1151001700	1151501700	1152001700	1153001700



ZAHNRIEMEN ZOLL – ISO 5296

XH

Teilung 7/8" (22,225 mm)

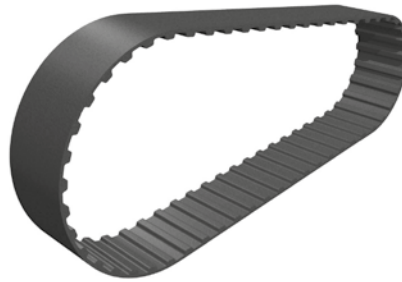

Werkstoff: Neopren

Beschreibung	Zähne- zahl	Nennlänge		Artikelnr. XH 200 Breite 50,80 mm	Artikelnr. XH 300 Breite 76,20 mm	Artikelnr. XH 400 Breite 101,60 mm
		Zoll	mm			
507 XH	58	50,75	1289,05	1162000507	1163000507	1164000507
560 XH	64	56,00	1422,40	1162000560	1163000560	1164000560
630 XH	72	63,00	1600,20	1162000630	1163000630	1164000630
700 XH	80	70,00	1778,00	1162000700	1163000700	1164000700
770 XH	88	77,00	1955,80	1162000770	1163000770	1164000770
840 XH	96	84,00	2133,60	1162000840	1163000840	1164000840
980 XH	112	98,00	2489,20	1162000980	1163000980	1164000980
1120 XH	128	112,00	2844,80	1162001120	1163001120	1164001120
1260 XH	144	126,00	3200,40	1162001260	1163001260	1164001260
1400 XH	160	140,00	3556,00	1162001400	1163001400	1164001400
1540 XH	176	154,00	3911,60	1162001540	1163001540	1164001540
1750 XH	200	175,00	4445,00	1162001750	1163001750	1164001750



ZAHNRIEMEN PROFIL HTD®

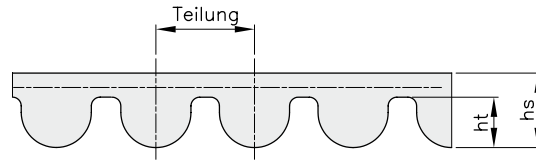

Werkstoff: Neopren mit Fiberglaseinlagen

ABMESSUNGEN UND TOLERANZEN DER DICKE

Typ	Teilung mm	hs mm	Tol. mm	ht mm
HTD 3M	3	2,4	± 0,20	1,2
HTD 5M	5	3,6	± 0,25	2,1
HTD 8M	8	5,6	± 0,40	3,4
HTD 14M	14	10,0	± 0,60	6,1

BREITENTOLERANZEN

Nennlänge	Breitentoleranz auf Teilungslänge		
	bis 880 mm	> 880 bis 1760 mm	> 1760 mm
≤ 9	+ 0,4 - 0,8	+ 0,4 - 0,8	
> 9 – 40	+ 0,8 - 0,8	+ 0,8 - 1,2	+ 0,8 - 1,2
> 40 – 50	+ 0,8 - 1,2	+ 1,2 - 1,2	+ 1,2 - 1,5
> 50 – 85	+ 1,2 - 1,2	+ 1,5 - 1,5	+ 1,5 - 2,0
> 85 – 170	+ 1,5 - 1,5	+ 1,5 - 2,0	+ 2,0 - 2,0
> 170		+ 4,8 - 4,8	+ 4,8 - 4,8

AUSWAHLTABELLE RIEMENTEILUNG

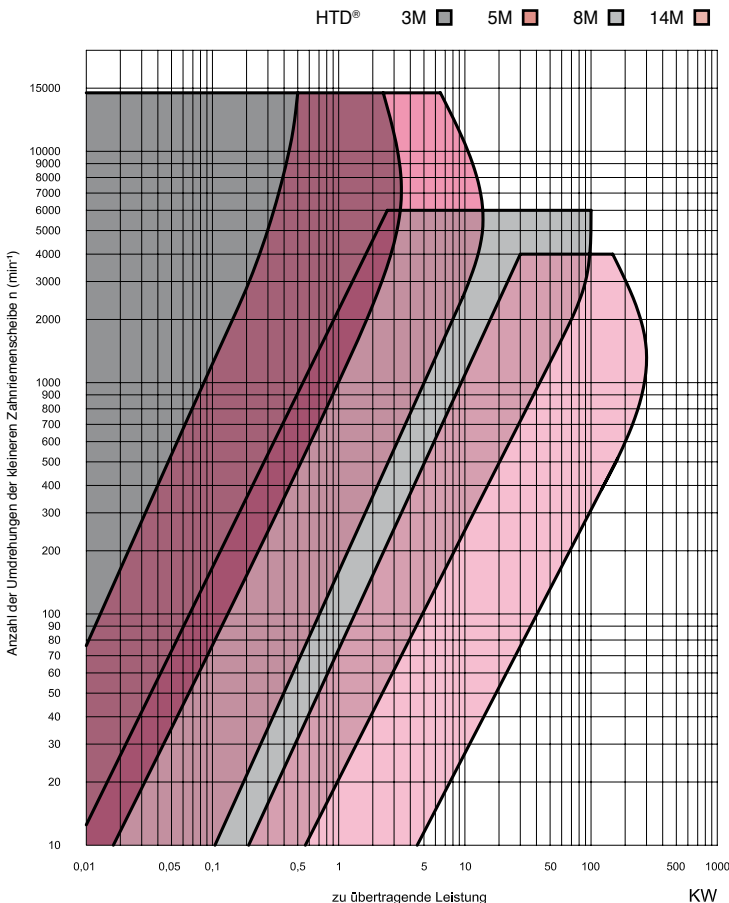

LÄNGENTOLERANZEN

Wirklänge mm	Toleranz mm
≤ 150	± 0,30
> 150 – 255	± 0,40
> 255 – 400	± 0,45
> 400 – 560	± 0,50
> 560 – 800	± 0,60
> 800 – 1000	± 0,65
> 1000 – 1270	± 0,75
> 1270 – 1500	± 0,80
> 1500 – 1800	± 0,85
> 1800 – 2000	± 0,90
> 2000 – 2250	± 0,95
> 2250	± 0,95 *

* Für alle 250 mm Länge muss eine Toleranz von 0,05 mm dazugezählt werden.



ZAHNRIEMEN „HTD®“

HTD 3M

Teilung 3 mm

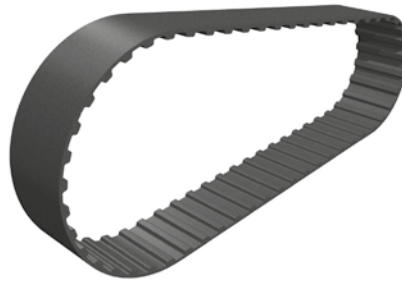

Werkstoff: Neopren

Beschreibung	Zähnezahl	Wirklänge mm	Artikelnr. HTD 3 Breite 6 mm	Artikelnr. HTD 3 Breite 9 mm	Artikelnr. HTD 3 Breite 15 mm
111 3M	37	111	1400060111	1400090111	1400150111
129 3M	43	129	1400060129	1400090129	1400150129
141 3M	47	141	1400060141	1400090141	1400150141
144 3M	48	144	1400060144	1400090144	1400150144
150 3M	50	150	1400060150	1400090150	1400150150
159 3M	53	159	1400060159	1400090159	1400150159
165 3M	55	165	1400060165	1400090165	1400150165
168 3M	56	168	1400060168	1400090168	1400150168
174 3M	58	174	1400060174	1400090174	1400150174
177 3M	59	177	1400060177	1400090177	1400150177
180 3M	60	180	1400060180	1400090180	1400150180
186 3M	62	186	1400060186	1400090186	1400150186
195 3M	65	195	1400060195	1400090195	1400150195
201 3M	67	201	1400060201	1400090201	1400150201
204 3M	68	204	1400060204	1400090204	1400150204
210 3M	70	210	1400060210	1400090210	1400150210
213 3M	71	213	1400060213	1400090213	1400150213
216 3M	72	216	1400060216	1400090216	1400150216
225 3M	75	225	1400060225	1400090225	1400150225
240 3M	80	240	1400060240	1400090240	1400150240
246 3M	82	246	1400060246	1400090246	1400150246
252 3M	84	252	1400060252	1400090252	1400150252
255 3M	85	255	1400060255	1400090255	1400150255
267 3M	89	267	1400060267	1400090267	1400150267
276 3M	92	276	1400060276	1400090276	1400150276
282 3M	94	282	1400060282	1400090282	1400150282
285 3M	95	285	1400060285	1400090285	1400150285
288 3M	96	288	1400060288	1400090288	1400150288
291 3M	97	291	1400060291	1400090291	1400150291
294 3M	98	294	1400060294	1400090294	1400150294
300 3M	100	300	1400060300	1400090300	1400150300
312 3M	104	312	1400060312	1400090312	1400150312
318 3M	106	318	1400060318	1400090318	1400150318
330 3M	110	330	1400060330	1400090330	1400150330
333 3M	111	333	1400060333	1400090333	1400150333
336 3M	112	336	1400060336	1400090336	1400150336
339 3M	113	339	1400060339	1400090339	1400150339
357 3M	119	357	1400060357	1400090356	1400150357
363 3M	121	363	1400060363	1400090363	1400150363
384 3M	128	384	1400060384	1400090384	1400150384
390 3M	130	390	1400060390	1400090390	1400150390



ZAHNRIEMEN „HTD®“

HTD 3M

Teilung 3 mm

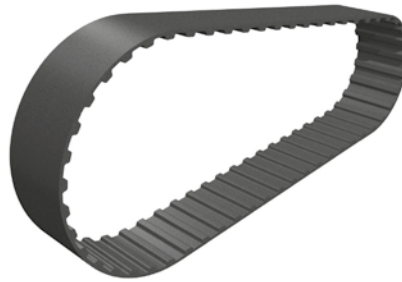

Werkstoff: Neopren

Beschreibung	Zähnezahl	Wirklänge mm	Artikelnr. HTD 3 Breite 6 mm	Artikelnr. HTD 3 Breite 9 mm	Artikelnr. HTD 3 Breite 15 mm
420 3M	140	420	1400060420	1400090420	1400150420
447 3M	149	447	1400060447	1400090447	1400150447
462 3M	154	462	1400060462	1400090462	1400150462
474 3M	158	474	1400060474	1400090474	1400150474
480 3M	160	480	1400060480	1400090480	1400150480
486 3M	162	486	1400060486	1400090486	1400150486
501 3M	167	501	1400060501	1400090501	1400150501
513 3M	171	513	1400060513	1400090513	1400150513
522 3M	174	522	1400060522	1400090522	1400150522
525 3M	175	525	1400060525	1400090525	1400150525
537 3M	179	537	1400060537	1400090537	1400150537
564 3M	188	564	1400060564	1400090564	1400150564
570 3M	190	570	1400060570	1400090570	1400150570
597 3M	199	597	1400060597	1400090597	1400150597
600 3M	200	600	1400060600	1400090600	1400150600
606 3M	202	606	1400060606	1400090606	1400150606
633 3M	211	633	1400060633	1400090633	1400150633
669 3M	223	669	1400060669	1400090669	1400150669
708 3M	236	708	1400060708	1400090708	1400150708
711 3M	237	711	1400060711	1400090711	1400150711
738 3M	246	738	1400060738	1400090738	1400150738
753 3M	251	753	1400060753	1400090753	1400150753
804 3M	268	804	1400060804	1400090804	1400150804
822 3M	274	822	1400060822	1400090822	1400150822
843 3M	281	843	1400060843	1400090843	1400150843
882 3M	294	882	1400060882	1400090882	1400150882
945 3M	315	945	1400060945	1400090945	1400150945
*1002 3M	334	1002	1400061002	1400091002	1400151002
1041 3M	347	1041	1400061041	1400091041	1400151041
1068 3M	356	1068	1400061068	1400091068	1400151068
1071 3M	357	1071	1400061071	1400091071	1400151071
1125 3M	375	1125	1400061125	1400091125	1400151125
1245 3M	415	1245	1400061245	1400091245	1400151245
1500 3M	500	1500	1400061500	1400091500	1400151500
1569 3M	523	1569	1400061569	1400091569	1400151569



ZAHNRIEMEN „HTD®“

HTD 5M

Teilung 5 mm

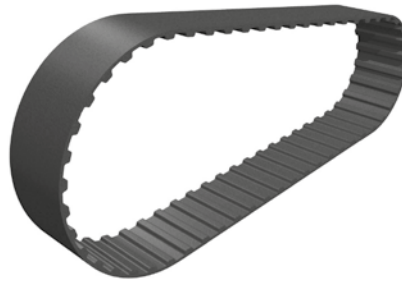

Werkstoff: Neopren

Beschreibung	Zähnezahl	Wirklänge mm	Artikelnr. HTD 5 Breite 9 mm	Artikelnr. HTD 5 Breite 15 mm	Artikelnr. HTD 5 Breite 25 mm
225 5M	45	225	1410090225	1410150225	1410250225
265 5M	53	265	1410090265	1410150265	1410250265
275 5M	55	275	1410090275	1410150275	1410250275
295 5M	59	295	1410090295	1410150295	1410250295
300 5M	60	300	1410090300	1410150300	1410250300
325 5M	65	325	1410090325	1410150325	1410250325
330 5M	66	330	1410090330	1410150330	1410250330
350 5M	70	350	1410090350	1410150350	1410250350
375 5M	75	375	1410090375	1410150375	1410250375
385 5M	77	385	1410090385	1410150385	1410250385
400 5M	80	400	1410090400	1410150400	1410250400
420 5M	84	420	1410090420	1410150420	1410250420
425 5M	85	425	1410090425	1410150425	1410250425
450 5M	90	450	1410090450	1410150450	1410250450
460 5M	92	460	1410090460	1410150460	1410250460
475 5M	95	475	1410090475	1410150475	1410250475
500 5M	100	500	1410090500	1410150500	1410250500
525 5M	105	525	1410090525	1410150525	1410250525
535 5M	107	535	1410090535	1410150535	1410250535
550 5M	110	550	1410090550	1410150550	1410250550
565 5M	113	565	1410090565	1410150565	1410250565
575 5M	115	575	1410090575	1410150575	1410250575
600 5M	120	600	1410090600	1410150600	1410250600
615 5M	123	615	1410090615	1410150615	1410250615
620 5M	124	620	1410090620	1410150620	1410250620
630 5M	126	630	1410090630	1410150630	1410250630
635 5M	127	635	1410090635	1410150635	1410250635
665 5M	133	665	1410090665	1410150665	1410250665
670 5M	134	670	1410090670	1410150670	1410250670
700 5M	140	700	1410090700	1410150700	1410250700
710 5M	142	710	1410090710	1410150710	1410250710
740 5M	148	740	1410090740	1410150740	1410250740
750 5M	150	750	1410090750	1410150750	1410250750
755 5M	151	755	1410090755	1410150755	1410250755
800 5M	160	800	1410090800	1410150800	1410250800
835 5M	167	835	1410090835	1410150835	1410250835
850 5M	170	850	1410090850	1410150850	1410250850
860 5M	172	860	1410090860	1410150860	1410250860
890 5M	178	890	1410090890	1410150890	1410250890
900 5M	180	900	1410090900	1410150900	1410250900
925 5M	185	925	1410090925	1410150925	1410250925



ZAHNRIEMEN „HTD®“

HTD 5M

Teilung 5 mm

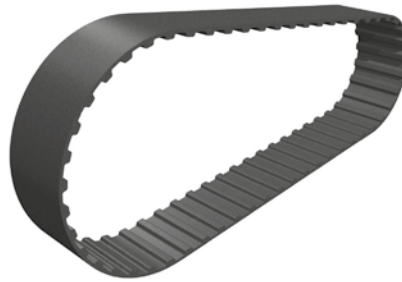

Werkstoff: Neopren

Beschreibung	Zähnezahl	Wirklänge mm	Artikelnr. HTD 5 Breite 9 mm	Artikelnr. HTD 5 Breite 15 mm	Artikelnr. HTD 5 Breite 25 mm
940 5M	188	940	1410090940	1410150940	1410250940
950 5M	190	950	1410090950	1410150950	1410250950
1000 5M	200	1000	1410091000	1410151000	1410251000
1050 5M	210	1050	1410091050	1410151050	1410251050
1125 5M	225	1125	1410091125	1410151125	1410251125
◇ 1195 5M	239	1195	1410091195	1410151195	1410251195
1200 5M	240	1200	1410091200	1410151200	1410251200
1270 5M	254	1270	1410091270	1410151270	1410251270
1300 5M	260	1300	1410091300	1410151300	1410251300
1350 5M	270	1350	1410091350	1410151350	1410251350
1420 5M	284	1420	1410091420	1410151420	1410251420
1500 5M	300	1500	1410091500	1410151500	1410251500
1595 5M	319	1595	1410091595	1410151595	1410251595
1690 5M	338	1690	1410091690	1410151690	1410251690
1800 5M	360	1800	1410091800	1410151800	1410251800
◇ 1895 5M	379	1895	1410091895	1410151895	1410251895
2000 5M	400	2000	1410092000	1410152000	1410252000
2525 5M	505	2525	1410092525	1410152525	1410252525



ZAHNRIEMEN „HTD®“

HTD 8M

Teilung 8 mm

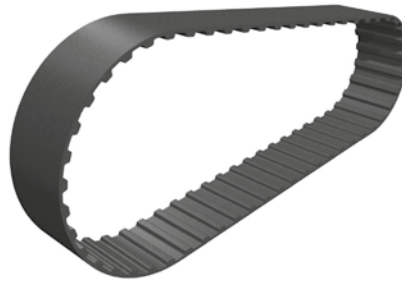

Werkstoff: Neopren

Beschreibung	Zähnezahl	Wirklänge mm	Artikelnr. HTD 8 Breite 20 mm	Artikelnr. HTD 8 Breite 30 mm	Artikelnr. HTD 8 Breite 50 mm	Artikelnr. HTD 8 Breite 85 mm
288 8M	36	288	1420200288	1420300288	1420500288	1420850288
352 8M	44	352	1420200352	1420300352	1420500352	1420850352
376 8M	47	376	1420200376	1420300376	1420500376	1420850376
400 8M	50	400	1420200400	1420300400	1420500400	1420850400
416 8M	52	416	1420200416	1420300416	1420500416	1420850416
424 8M	53	424	1420200424	1420300424	1420500424	1420850424
472 8M	59	472	1420200472	1420300472	1420500472	1420850472
480 8M	60	480	1420200480	1420300480	1420500480	1420850480
512 8M	64	512	1420200512	1420300512	1420500512	1420850512
520 8M	65	520	1420200520	1420300520	1420500520	1420850520
536 8M	67	536	1420200536	1420300536	1420500536	1420850536
560 8M	70	560	1420200560	1420300560	1420500560	1420850560
576 8M	72	576	1420200576	1420300576	1420500576	1420850576
600 8M	75	600	1420200600	1420300600	1420500600	1420850600
624 8M	78	624	1420200624	1420300624	1420500624	1420850624
632 8M	79	632	1420200632	1420300632	1420500632	1420850632
640 8M	80	640	1420200640	1420300640	1420500640	1420850640
656 8M	82	656	1420200656	1420300656	1420500656	1420850656
688 8M	86	688	1420200688	1420300688	1420500688	1420850688
720 8M	90	720	1420200720	1420300720	1420500720	1420850720
760 8M	95	760	1420200760	1420300760	1420500760	1420850760
776 8M	97	776	1420200776	1420300776	1420500776	1420850776
784 8M	98	784	1420200784	1420300784	1420500784	1420850784
800 8M	100	800	1420200800	1420300800	1420500800	1420850800
880 8M	110	880	1420200880	1420300880	1420500880	1420850880
912 8M	114	912	1420200912	1420300912	1420500912	1420850912
920 8M	115	920	1420200920	1420300920	1420500920	1420850920
960 8M	120	960	1420200960	1420300960	1420500960	1420850960
1000 8M	125	1000	1420201000	1420301000	1420501000	1420851000
1016 8M	127	1016	1420201016	1420301016	1420501016	1420851016
1040 8M	130	1040	1420201040	1420301040	1420501040	1420851040
1064 8M	133	1064	1420201064	1420301064	1420501064	1420851064
1080 8M	135	1080	1420201080	1420301080	1420501080	1420851080
1120 8M	140	1120	1420201120	1420301120	1420501120	1420851120
1152 8M	144	1152	1420201152	1420301152	1420501152	1420851152
1160 8M	145	1160	1420201160	1420301160	1420501160	1420851160
1172 8M	147	1172	1420201172	1420301176	1420501176	1420851176
1200 8M	150	1200	1420201200	1420301200	1420501200	1420851200
1224 8M	153	1224	1420201224	1420301224	1420501224	1420851224
1256 8M	157	1256	1420201256	1420301256	1420501256	1420851256
1280 8M	160	1280	1420201280	1420301280	1420501280	1420851280



ZAHNRIEMEN „HTD®“

HTD 8M

Teilung 8 mm

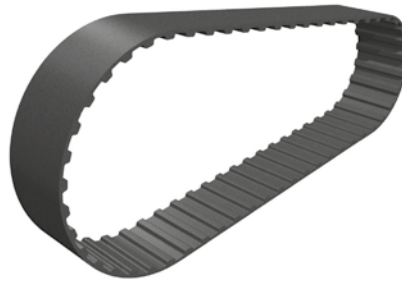

Werkstoff: Neopren

Beschreibung	Zähnezahl	Wirklänge mm	Artikelnr. HTD 8 Breite 20 mm	Artikelnr. HTD 8 Breite 30 mm	Artikelnr. HTD 8 Breite 50 mm	Artikelnr. HTD 8 Breite 85 mm
1304 8M	163	1304	1420201304	1420301304	1420501304	1420851304
1328 8M	166	1328	1420201328	1420301328	1420501328	1420851328
1360 8M	170	1360	1420201360	1420301360	1420501360	1420851360
1392 8M	174	1392	1420201392	1420301392	1420501392	1420851392
1424 8M	178	1424	1420201424	1420301424	1420501424	1420851424
1440 8M	180	1440	1420201440	1420301440	1420501440	1420851440
1520 8M	190	1520	1420201520	1420301520	1420501520	1420851520
1552 8M	194	1552	1420201552	1420301552	1420501552	1420851552
1600 8M	200	1600	1420201600	1420301600	1420501600	1420851600
1696 8M	212	1696	1420201696	1420301696	1420501696	1420851696
1760 8M	220	1760	1420201760	1420301760	1420501760	1420851760
1800 8M	225	1800	1420201800	1420301800	1420501800	1420851800
2000 8M	250	2000	1420202000	1420302000	1420502000	1420852000
2240 8M	280	2240	1420202240	1420302240	1420502240	1420852240
2248 8M	281	2248	1420202248	1420302248	1420502248	1420852248
2400 8M	300	2400	1420202400	1420302400	1420502400	1420852400
2600 8M	325	2600	1420202600	1420302600	1420502600	1420852600
2800 8M	350	2800	1420202800	1420302800	1420502800	1420852800
3008 8M	376	3008	1420203008	1420303008	1420503008	1420853008
3048 8M	381	3048	1420203048	1420303048	1420503048	1420853048
3280 8M	410	3280	1420203280	1420303280	1420503280	1420853280
3600 8M	450	3600	1420203600	1420303600	1420503600	1420853600
3808 8M	476	3808	1420203808	1420303808	1420503808	1420853808
4400 8M	550	4400	1420204400	1420304400	1420504400	1420854400



ZAHNRIEMEN „HTD®“

HTD 14M

Teilung 14 mm

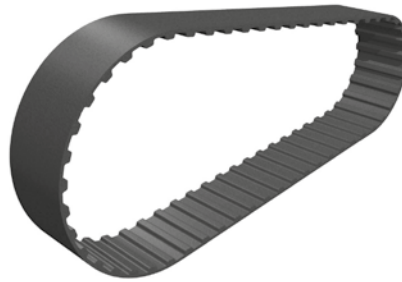

Werkstoff: Neopren

Beschreibung	Zähnezahl	Wirklänge mm	Artikelnr. HTD 14 Breite 40 mm	Artikelnr. HTD 14 Breite 55 mm	Artikelnr. HTD 14 Breite 85 mm	Artikelnr. HTD 14 Breite 115 mm	Artikelnr. HTD 14 Breite 170 mm
966 14M	69	966	1430400966	1430550966	1430850966	1431150966	1431700966
1190 14M	85	1190	1430401190	1430551190	1430851190	1431151190	1431701190
1400 14M	100	1400	1430401400	1430551400	1430851400	1431151400	1431701400
◇ 1442 14M	103	1442	1430401442	1430551442	1430851442	1431151442	1431701442
1610 14M	115	1610	1430401610	1430551610	1430851610	1431151610	1431701610
1778 14M	127	1778	1430401778	1430551778	1430851778	1431151778	1431701778
1890 14M	135	1890	1430401890	1430551890	1430851890	1431151890	1431701890
2100 14M	150	2100	1430402100	1430552100	1430852100	1431152100	1431702100
2310 14M	165	2310	1430402310	1430552310	1430852310	1431152310	1431702310
2450 14M	175	2450	1430402450	1430552450	1430852450	1431152450	1431702450
2590 14M	185	2590	1430402590	1430552590	1430852590	1431152590	1431702590
2800 14M	200	2800	1430402800	1430552800	1430852800	1431152800	1431702800
3150 14M	225	3150	1430403150	1430553150	1430853150	1431153150	1431703150
3360 14M	240	3360	1430403360	1430553360	1430853360	1431153360	1431703360
3500 14M	250	3500	1430403500	1430553500	1430853500	1431153500	1431703500
3850 14M	275	3850	1430403850	1430553850	1430853850	1431153850	1431703850
4326 14M	309	4326	1430404326	1430554326	1430854326	1431154326	1431704326
4578 14M	327	4578	1430404578	1430554578	1430854578	1431154578	

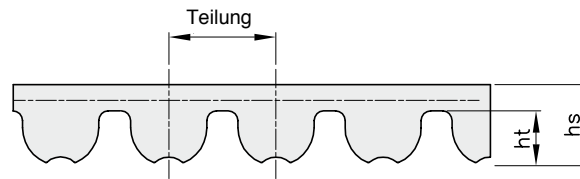

Werkstoff: Neopren mit Fiberglaseinlagen

ABMESSUNGEN UND TOLERANZEN DER DICKE

Typ	Teilung mm	hs mm	Tol. mm	ht mm
HTD 5M HP	5	3,4	± 0,25	1,9
HTD 8M HP	8	5,4	± 0,40	3,2
HTD 14M HP	14	9,5	± 0,60	5,6

BREITENTOLERANZEN

Nennlänge	Breitentoleranz auf Teilungslänge		
	bis 838,2 mm	> 838,3 bis 1676,4 mm	> 1676,4 mm
> 2,9 – 11,0	+ 0,4 - 0,8	+ 0,4 - 0,8	
> 11,1 – 38,1	+ 0,8 - 0,8	+ 0,8 - 0,8	+ 0,8 - 1,2
> 38,2 – 50,8	+ 0,8 - 1,2	+ 1,2 - 1,2	+ 1,2 - 1,6
> 50,9 – 63,5	+ 1,2 - 1,2	+ 1,2 - 1,6	+ 1,6 - 1,6
> 63,6 – 76,2	+ 1,2 - 1,6	+ 1,6 - 1,6	+ 1,6 - 2,0
> 76,3 – 101,6	+ 1,6 - 1,6	+ 1,6 - 2,0	+ 2,0 - 2,0
> 101,7 – 177,8	+ 2,4 - 2,4	+ 1,6 - 2,0	+ 2,0 - 2,0
> 177,9			+ 4,8 - 6,4

AUSWAHLTABELLE RIEMENTEILUNG

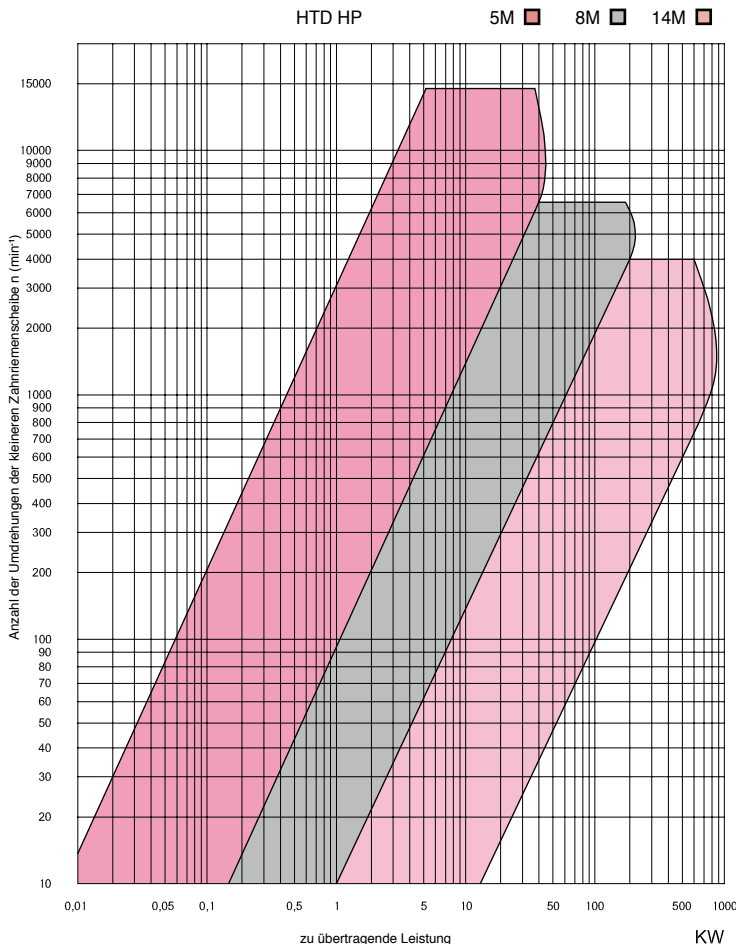

LÄNGENTOLERANZEN

Wirklänge mm	Toleranz mm
≤ 250	± 0,20
> 250 – 500	± 0,23
> 500 – 750	± 0,27
> 750 – 1000	± 0,30
> 1000 – 1250	± 0,33
> 1250 – 1500	± 0,36
> 1500 – 1750	± 0,39
> 1750 – 2000	± 0,42
> 2000 – 2250	± 0,46
> 2250 – 2500	± 0,49
> 2500 – 2750	± 0,52
> 2750 – 3000	± 0,55
> 3000	± 0,55*

* Für alle 250 mm Länge muss eine Toleranz von 0,03 mm dazugezählt werden.



ZAHNRIEMEN „HP/CXP“ FÜR HOHE LEISTUNG

HTD 5M HP/CXP

Teilung 5 mm

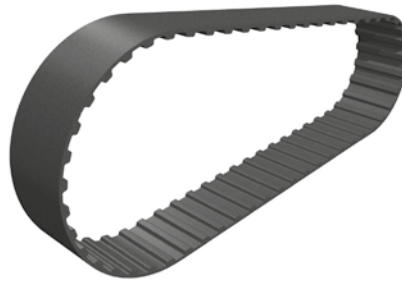

Werkstoff: Neopren

Beschreibung	Zähnezahl	Wirklänge mm	Artikelnr. HTD 5M HP/CXP Breite 9 mm	Artikelnr. HTD 5M HP/CXP Breite 15 mm	Artikelnr. HTD 5M HP/CXP Breite 25 mm
180 5M HP/CXP	36	180	HP1410090180	HP1410150180	HP1410250180
225 5M HP/CXP	45	225	HP1410090225	HP1410150225	HP1410250225
235 5M HP/CXP	47	235	HP1410090235	HP1410150235	HP1410250235
265 5M HP/CXP	53	265	HP1410090265	HP1410150265	HP1410250265
275 5M HP/CXP	55	275	HP1410090275	HP1410150275	HP1410250275
295 5M HP/CXP	59	295	HP1410090295	HP1410150295	HP1410250295
300 5M HP/CXP	60	300	HP1410090300	HP1410150300	HP1410250300
325 5M HP/CXP	65	325	HP1410090325	HP1410150325	HP1410250325
330 5M HP/CXP	66	330	HP1410090330	HP1410150330	HP1410250330
340 5M HP/CXP	68	340	HP1410090340	HP1410150340	HP1410250340
350 5M HP/CXP	70	350	HP1410090350	HP1410150350	HP1410250350
375 5M HP/CXP	75	375	HP1410090375	HP1410150375	HP1410250375
390 5M HP/CXP	78	390	HP1410090390	HP1410150390	HP1410250390
400 5M HP/CXP	80	400	HP1410090400	HP1410150400	HP1410250400
405 5M HP/CXP	81	405	HP1410090405	HP1410150405	HP1410250405
415 5M HP/CXP	83	415	HP1410090415	HP1410150415	HP1410250415
425 5M HP/CXP	85	425	HP1410090425	HP1410150425	HP1410250425
450 5M HP/CXP	90	450	HP1410090450	HP1410150450	HP1410250450
460 5M HP/CXP	92	460	HP1410090460	HP1410150460	HP1410250460
475 5M HP/CXP	95	475	HP1410090475	HP1410150475	HP1410250475
490 5M HP/CXP	98	490	HP1410090490	HP1410150490	HP1410250490
500 5M HP/CXP	100	500	HP1410090500	HP1410150500	HP1410250500
520 5M HP/CXP	104	520	HP1410090520	HP1410150520	HP1410250520
525 5M HP/CXP	105	525	HP1410090525	HP1410150525	HP1410250525
535 5M HP/CXP	107	535	HP1410090535	HP1410150535	HP1410250535
550 5M HP/CXP	110	550	HP1410090550	HP1410150550	HP1410250550
565 5M HP/CXP	113	565	HP1410090565	HP1410150565	HP1410250565
600 5M HP/CXP	120	600	HP1410090600	HP1410150600	HP1410250600
615 5M HP/CXP	123	615	HP1410090615	HP1410150615	HP1410250615
620 5M HP/CXP	124	620	HP1410090620	HP1410150620	HP1410250620
630 5M HP/CXP	126	630	HP1410090630	HP1410150630	HP1410250630
635 5M HP/CXP	127	635	HP1410090635	HP1410150635	HP1410250635
650 5M HP/CXP	130	650	HP1410090650	HP1410150650	HP1410250650
665 5M HP/CXP	133	665	HP1410090665	HP1410150665	HP1410250665
700 5M HP/CXP	140	700	HP1410090700	HP1410150700	HP1410250700
710 5M HP/CXP	142	710	HP1410090710	HP1410150710	HP1410250710
740 5M HP/CXP	148	740	HP1410090740	HP1410150740	HP1410250740
750 5M HP/CXP	150	750	HP1410090750	HP1410150750	HP1410250750
755 5M HP/CXP	151	755	HP1410090755	HP1410150755	HP1410250755
775 5M HP/CXP	155	775	HP1410090775	HP1410150775	HP1410250775
800 5M HP/CXP	160	800	HP1410090800	HP1410150800	HP1410250800



ZAHNRIEMEN „HP/CXP“ FÜR HOHE LEISTUNG

HTD 5M HP/CXP

Teilung 5 mm

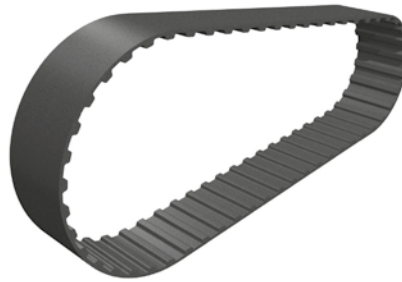

Werkstoff: Neopren

Beschreibung	Zähnezahl	Wirklänge mm	Artikelnr. HTD 5M HP/CXP Breite 9 mm	Artikelnr. HTD 5M HP/CXP Breite 15 mm	Artikelnr. HTD 5M HP/CXP Breite 25 mm
835 5M HP/CXP	167	835	HP1410090835	HP1410150835	HP1410250835
840 5M HP/CXP	168	840	HP1410090840	HP1410150840	HP1410250840
850 5M HP/CXP	170	850	HP1410090850	HP1410150850	HP1410250850
860 5M HP/CXP	172	860	HP1410090860	HP1410150860	HP1410250860
890 5M HP/CXP	178	890	HP1410090890	HP1410150890	HP1410250890
900 5M HP/CXP	180	900	HP1410090900	HP1410150900	HP1410250900
925 5M HP/CXP	185	925	HP1410090925	HP1410150925	HP1410250925
950 5M HP/CXP	190	950	HP1410090950	HP1410150950	HP1410250950
1000 5M HP/CXP	200	1000	HP1410091000	HP1410151000	HP1410251000
1050 5M HP/CXP	210	1050	HP1410091050	HP1410151050	HP1410251050
1125 5M HP/CXP	225	1125	HP1410091125	HP1410151125	HP1410251125
1135 5M HP/CXP	227	1135	HP1410091135	HP1410151135	HP1410251135
1200 5M HP/CXP	240	1200	HP1410091200	HP1410151200	HP1410251200
1270 5M HP/CXP	254	1270	HP1410091270	HP1410151270	HP1410251270
1420 5M HP/CXP	284	1420	HP1410091420	HP1410151420	HP1410251420
1500 5M HP/CXP	300	1500	HP1410091500	HP1410151500	HP1410251500
1690 5M HP/CXP	338	1690	HP1410091690	HP1410151690	HP1410251690
2000 5M HP/CXP	400	2000	HP1410092000	HP1410152000	HP1410252000
2110 5M HP/CXP	422	2110	HP1410092110	HP1410152110	HP1410252110



ZAHNRIEMEN „HP/CXP“ FÜR HOHE LEISTUNG

HTD 8M HP/CXP

Teilung 8 mm

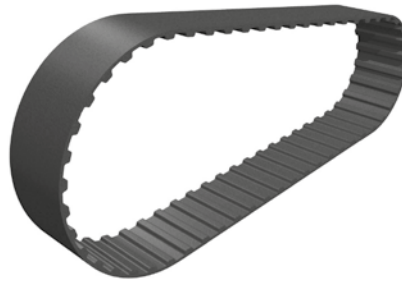

Werkstoff: Neopren

Beschreibung	Zähnezahl	Wirklänge mm	Artikelnr. HTD 8M HP/CXP Breite 20 mm	Artikelnr. HTD 8M HP/CXP Breite 30 mm	Artikelnr. HTD 8M HP/CXP Breite 50 mm	Artikelnr. HTD 8M HP/CXP Breite 85 mm
288 8M HP/CXP	36	288	HP1420200288	HP1420300288	HP1420500288	HP1420850288
304 8M HP/CXP	38	304	HP1420200304	HP1420300304	HP1420500304	HP1420850304
352 8M HP/CXP	44	352	HP1420200352	HP1420300352	HP1420500352	HP1420850352
376 8M HP/CXP	47	376	HP1420200376	HP1420300376	HP1420500376	HP1420850376
384 8M HP/CXP	48	384	HP1420200384	HP1420300384	HP1420500384	HP1420850384
400 8M HP/CXP	50	400	HP1420200400	HP1420300400	HP1420500400	HP1420850400
416 8M HP/CXP	52	416	HP1420200416	HP1420300416	HP1420500416	HP1420850416
424 8M HP/CXP	53	424	HP1420200424	HP1420300424	HP1420500424	HP1420850424
480 8M HP/CXP	60	480	HP1420200480	HP1420300480	HP1420500480	HP1420850480
560 8M HP/CXP	70	560	HP1420200560	HP1420300560	HP1420500560	HP1420850560
600 8M HP/CXP	75	600	HP1420200600	HP1420300600	HP1420500600	HP1420850600
624 8M HP/CXP	78	624	HP1420200624	HP1420300624	HP1420500624	HP1420850624
640 8M HP/CXP	80	640	HP1420200640	HP1420300640	HP1420500640	HP1420850640
656 8M HP/CXP	82	656	HP1420200656	HP1420300656	HP1420500656	HP1420850656
720 8M HP/CXP	90	720	HP1420200720	HP1420300720	HP1420500720	HP1420850720
776 8M HP/CXP	97	776	HP1420200776	HP1420300776	HP1420500776	HP1420850776
784 8M HP/CXP	98	784	HP1420200784	HP1420300784	HP1420500784	HP1420850784
800 8M HP/CXP	100	800	HP1420200800	HP1420300800	HP1420500800	HP1420850800
840 8M HP/CXP	105	840	HP1420200840	HP1420300840	HP1420500840	HP1420850840
880 8M HP/CXP	110	880	HP1420200880	HP1420300880	HP1420500880	HP1420850880
912 8M HP/CXP	114	912	HP1420200912	HP1420300912	HP1420500912	HP1420850912
920 8M HP/CXP	115	920	HP1420200920	HP1420300920	HP1420500920	HP1420850920
960 8M HP/CXP	120	960	HP1420200960	HP1420300960	HP1420500960	HP1420850960
1040 8M HP/CXP	130	1040	HP1420201040	HP1420301040	HP1420501040	HP1420851040
1064 8M HP/CXP	133	1064	HP1420201064	HP1420301064	HP1420501064	HP1420851064
1080 8M HP/CXP	135	1080	HP1420201080	HP1420301080	HP1420501080	HP1420851080
1120 8M HP/CXP	140	1120	HP1420201120	HP1420301120	HP1420501120	HP1420851120
1160 8M HP/CXP	145	1160	HP1420201160	HP1420301160	HP1420501160	HP1420851160
1200 8M HP/CXP	150	1200	HP1420201200	HP1420301200	HP1420501200	HP1420851200
1280 8M HP/CXP	160	1280	HP1420201280	HP1420301280	HP1420501280	HP1420851280
1304 8M HP/CXP	163	1304	HP1420201304	HP1420301304	HP1420501304	HP1420851304
1328 8M HP/CXP	166	1328	HP1420201328	HP1420301328	HP1420501328	HP1420851328
1360 8M HP/CXP	170	1360	HP1420201360	HP1420301360	HP1420501360	HP1420851360
1392 8M HP/CXP	174	1392	HP1420201392	HP1420301392	HP1420501392	HP1420851392
1424 8M HP/CXP	178	1424	HP1420201424	HP1420301424	HP1420501424	HP1420851424
1440 8M HP/CXP	180	1440	HP1420201440	HP1420301440	HP1420501440	HP1420851440
1456 8M HP/CXP	182	1456	HP1420201456	HP1420301456	HP1420501456	HP1420851456
1520 8M HP/CXP	190	1520	HP1420201520	HP1420301520	HP1420501520	HP1420851520
1584 8M HP/CXP	198	1584	HP1420201584	HP1420301584	HP1420501584	HP1420851584
1600 8M HP/CXP	200	1600	HP1420201600	HP1420301600	HP1420501600	HP1420851600
1760 8M HP/CXP	220	1760	HP1420201760	HP1420301760	HP1420501760	HP1420851760



ZAHNRIEMEN „HP/CXP“ FÜR HOHE LEISTUNG

HTD 8M HP/CXP

Teilung 8 mm



Werkstoff: Neopren

Beschreibung	Zähnezahl	Wirklänge mm	Artikelnr. HTD 8M HP/CXP Breite 20 mm	Artikelnr. HTD 8M HP/CXP Breite 30 mm	Artikelnr. HTD 8M HP/CXP Breite 50 mm	Artikelnr. HTD 8M HP/CXP Breite 85 mm
1800 8M HP/CXP	225	1800	HP1420201800	HP1420301800	HP1420501800	HP1420851800
2000 8M HP/CXP	250	2000	HP1420202000	HP1420302000	HP1420502000	HP1420852000
2104 8M HP/CXP	263	2104	HP1420202104	HP1420302104	HP1420502104	HP1420852104
2248 8M HP/CXP	281	2248	HP1420202248	HP1420302248	HP1420502248	HP1420852248
2400 8M HP/CXP	300	2400	HP1420202400	HP1420302400	HP1420502400	HP1420852400
2600 8M HP/CXP	325	2600	HP1420202600	HP1420302600	HP1420502600	HP1420852600
2800 8M HP/CXP	350	2800	HP1420202800	HP1420302800	HP1420502800	HP1420852800
3008 8M HP/CXP	376	3008	HP1420203008	HP1420303008	HP1420503008	HP1420853008
3048 8M HP/CXP	381	3048	HP1420203048	HP1420303048	HP1420503048	HP1420853048
3280 8M HP/CXP	410	3280	HP1420203280	HP1420303280	HP1420503280	HP1420853280
3408 8M HP/CXP	426	3408	HP1420203408	HP1420303408	HP1420503408	HP1420853408
3600 8M HP/CXP	450	3600	HP1420203600	HP1420303600	HP1420503600	HP1420853600
3808 8M HP/CXP	476	3808	HP1420203808	HP1420303808	HP1420503808	HP1420853808



ZAHNRIEMEN „HP/CXP“ FÜR HOHE LEISTUNG

HTD 14M HP/CXP

Teilung 14 mm

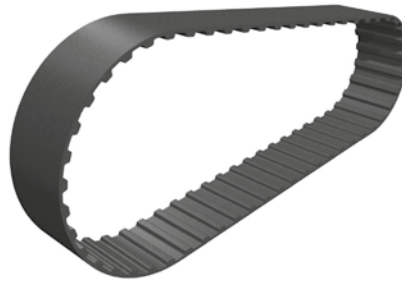

Werkstoff: Neopren

Beschreibung	Zähnezahl	Wirklänge mm	Artikelnr. HTD 14M HP/CXP Breite 40 mm	Artikelnr. HTD 14M HP/CXP Breite 55 mm	Artikelnr. HTD 14M HP/CXP Breite 85 mm	Artikelnr. HTD 14M HP/CXP Breite 115 mm	Artikelnr. HTD 14M HP/CXP Breite 170 mm
966 14M HP/CXP	69	966	HP1430400966	HP1430550966	HP1430850966	HP1431150966	HP1431700966
1050 14M HP/CXP	75	1050	HP1430401050	HP1430551050	HP1430851050	HP1431151050	HP1431701050
1190 14M HP/CXP	85	1190	HP1430401190	HP1430551190	HP1430851190	HP1431151190	HP1431701190
1400 14M HP/CXP	100	1400	HP1430401400	HP1430551400	HP1430851400	HP1431151400	HP1431701400
1610 14M HP/CXP	115	1610	HP1430401610	HP1430551610	HP1430851610	HP1431151610	HP1431701610
1680 14M HP/CXP	120	1680	HP1430401680	HP1430551680	HP1430851680	HP1431151680	HP1431701680
1778 14M HP/CXP	127	1778	HP1430401778	HP1430551778	HP1430851778	HP1431151778	HP1431701778
1890 14M HP/CXP	135	1890	HP1430401890	HP1430551890	HP1430851890	HP1431151890	HP1431701890
2100 14M HP/CXP	150	2100	HP1430402100	HP1430552100	HP1430852100	HP1431152100	HP1431702100
2310 14M HP/CXP	165	2310	HP1430402310	HP1430552310	HP1430852310	HP1431152310	HP1431702310
2450 14M HP/CXP	175	2450	HP1430402450	HP1430552450	HP1430852450	HP1431152450	HP1431702450
2590 14M HP/CXP	185	2590	HP1430402590	HP1430552590	HP1430852590	HP1431152590	HP1431702590
2800 14M HP/CXP	200	2800	HP1430402800	HP1430552800	HP1430852800	HP1431152800	HP1431702800
3150 14M HP/CXP	225	3150	HP1430403150	HP1430553150	HP1430853150	HP1431153150	HP1431703150
3360 14M HP/CXP	240	3360	HP1430403360	HP1430553360	HP1430853360	HP1431153360	HP1431703360
3500 14M HP/CXP	250	3500	HP1430403500	HP1430553500	HP1430853500	HP1431153500	HP1431703500
3668 14M HP/CXP	262	3668	HP1430403668	HP1430553668	HP1430853668	HP1431153668	HP1431703668
3850 14M HP/CXP	275	3850	HP1430403850	HP1430553850	HP1430853850	HP1431153850	HP1431703850
4326 14M HP/CXP	309	4326	HP1430404326	HP1430554326	HP1430854326	HP1431154326	HP1431704326
4578 14M HP/CXP	327	4578	HP1430404578	HP1430554578	HP1430854578	HP1431154578	HP1431704578

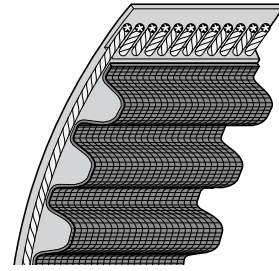
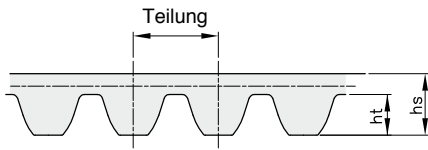

Eigenschaften

- resistent gegen Öl
- resistent gegen UV-Strahlen und Ozon
- wartungsfrei
- Temperaturbereich von -40°C bis 100°C

ABMESSUNGEN UND TOLERANZEN DER DICKE

Typ	Teilung mm	hs mm	Tol. mm	ht mm
CTD 8M	8	5,6	± 0,30	3,4
CTD 14M	14	10	± 0,45	6,1

BREITENTOLERANZEN

Nennlänge	8M	14M
bis 50	± 0,65 mm	± 1 mm
bis 100	± 1,3 mm	± 2 mm
bis 100	± 1,5 %	± 2 %

AUSWAHLTABELLE RIEMENTEILUNG

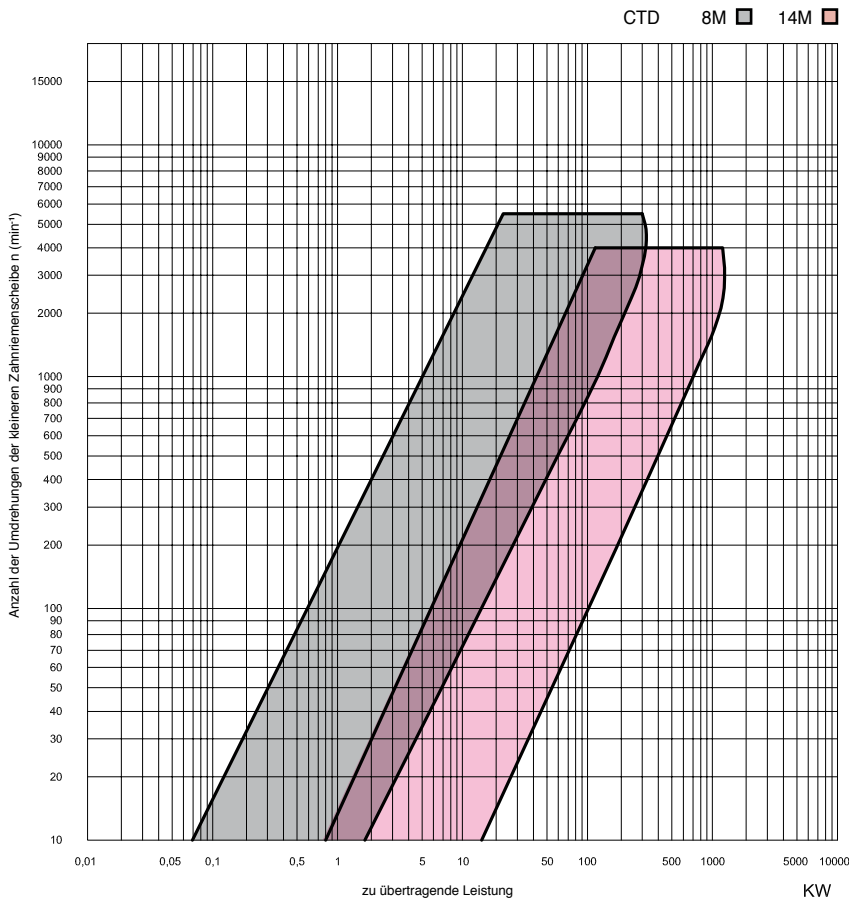

LÄNGENTOLERANZEN

Wirklänge	Toleranz in Bezug Achsabstand
640–1000	± 0,65 mm
1000–1960	± 1,3 mm
1960–3500	± 1,5 %
3500–4480	

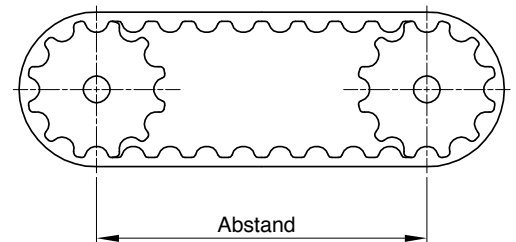



ZAHNRIEMEN SYNCHROCHAIN CARBON „CTD“

CTD 8M

Teilung 8 mm

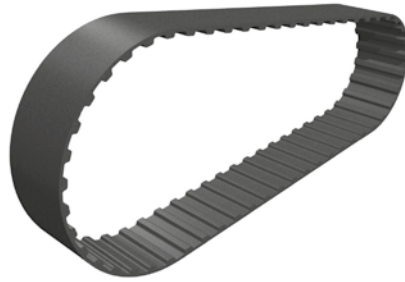

Riemenrücken aus Polyurethan

Zugstrang aus Carbon

Zähne aus Polyurethan

Spezialbehandeltes Gewebe

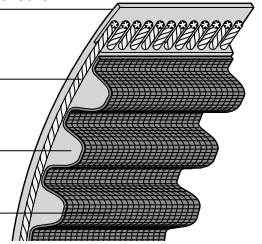

Werkstoff: Polyurethan

Beschreibung	Zähnezahl	Wirklänge mm	Artikelnr. CTD 8M Breite 12 mm	Artikelnr. CTD 8M Breite 21 mm	Artikelnr. CTD 8M Breite 36 mm	Artikelnr. CTD 8M Breite 62 mm
CTD 8M 640 C	80	640	SCC420120640	SCC420210640	SCC420360640	SCC420620640
CTD 8M 720 C	90	720	SCC420120720	SCC420210720	SCC420360720	SCC420620720
CTD 8M 800 C	100	800	SCC420120800	SCC420210800	SCC420360800	SCC420620800
CTD 8M 896 C	112	896	SCC420120896	SCC420210896	SCC420360896	SCC420620896
CTD 8M 920 C	115	920	SCC420120920	SCC420210920	SCC420360920	SCC420620920
CTD 8M 960 C	120	960	SCC420120960	SCC420210960	SCC420360960	SCC420620960
CTD 8M 1000 C	125	1000	SCC420121000	SCC420211000	SCC420361000	SCC420621000
CTD 8M 1040 C	130	1040	SCC420121040	SCC420211040	SCC420361040	SCC420621040
CTD 8M 1120 C	140	1120	SCC420121120	SCC420211120	SCC420361120	SCC420621120
CTD 8M 1200 C	150	1200	SCC420121200	SCC420211200	SCC420361200	SCC420621200
CTD 8M 1224 C	153	1224	SCC420121224	SCC420211224	SCC420361224	SCC420621224
CTD 8M 1280 C	160	1280	SCC420121280	SCC420211280	SCC420361280	SCC420621280
CTD 8M 1440 C	180	1440	SCC420121440	SCC420211440	SCC420361440	SCC420621440
CTD 8M 1600 C	200	1600	SCC420121600	SCC420211600	SCC420361600	SCC420621600
CTD 8M 1760 C	220	1760	SCC420121760	SCC420211760	SCC420361760	SCC420621760
CTD 8M 1792 C	224	1792	SCC420121792	SCC420211792	SCC420361792	SCC420621792
CTD 8M 2000 C	250	2000	SCC420122000	SCC420212000	SCC420362000	SCC420622000
CTD 8M 2400 C	300	2400	SCC420122400	SCC420212400	SCC420362400	SCC420622400
CTD 8M 2520 C	315	2520	SCC420122520	SCC420212520	SCC420362520	SCC420622520
CTD 8M 2840 C	355	2840	SCC420122840	SCC420212840	SCC420362840	SCC420622840
CTD 8M 3200 C	400	3200	SCC420123200	SCC420213200	SCC420363200	SCC420623200
CTD 8M 3600 C	450	3600	SCC420123600	SCC420213600	SCC420363600	SCC420623600
CTD 8M 4000 C	500	4000	SCC420124000	SCC420214000	SCC420364000	SCC420624000



ZAHNRIEMEN SYNCHROCHAIN CARBON „CTD“

CTD 14M

Teilung 14 mm



Riemenrücken aus Polyurethan

Zugstrang aus Carbon

Zähne aus Polyurethan

Spezialbehandeltes Gewebe

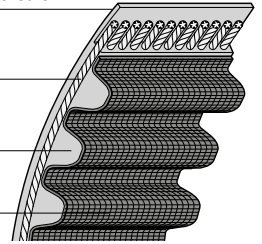

Werkstoff: Polyurethan

Beschreibung	Zähnezahl	Wirklänge mm	Art-nr. CTD 14M Breite 20 mm	Art-nr. CTD 14M Breite 37 mm	Art-nr. CTD 14M Breite 68 mm	Art-nr. CTD 14M Breite 90 mm	Art-nr. CTD 14M Breite 125 mm
CTD 14M 994 C	71	994	SCC430200994	SCC430370994	SCC430680994	SCC430900994	SCC431250994
CTD 14M 1120 C	80	1120	SCC430201120	SCC430371120	SCC430681120	SCC430901120	SCC431251120
CTD 14M 1190 C	85	1190	SCC430201190	SCC430371190	SCC430681190	SCC430901190	SCC431251190
CTD 14M 1260 C	90	1260	SCC430201260	SCC430371260	SCC430681260	SCC430901260	SCC431251260
CTD 14M 1344 C	96	1344	SCC430201344	SCC430371344	SCC430681344	SCC430901344	SCC431251344
CTD 14M 1400 C	100	1400	SCC430201400	SCC430371400	SCC430681400	SCC430901400	SCC431251400
CTD 14M 1568 C	112	1568	SCC430201568	SCC430371568	SCC430681568	SCC430901568	SCC431251568
CTD 14M 1610 C	115	1610	SCC430201610	SCC430371610	SCC430681610	SCC430901610	SCC431251610
CTD 14M 1750 C	125	1750	SCC430201750	SCC430371750	SCC430681750	SCC430901750	SCC431251750
CTD 14M 1890 C	135	1890	SCC430201890	SCC430371890	SCC430681890	SCC430901890	SCC431251890
CTD 14M 1960 C	140	1960	SCC430201960	SCC430371960	SCC430681960	SCC430901960	SCC431251960
CTD 14M 2100 C	1510	2100	SCC430202100	SCC430372100	SCC430682100	SCC430902100	SCC431252100
CTD 14M 2240 C	160	2240	SCC430202240	SCC430372240	SCC430682240	SCC430902240	SCC431252240
CTD 14M 2380 C	170	2380	SCC430202380	SCC430372380	SCC430682380	SCC430902380	SCC431252380
CTD 14M 2520 C	1180	2520	SCC430202520	SCC430372520	SCC430682520	SCC430902520	SCC431252520
CTD 14M 2660 C	190	2660	SCC430202660	SCC430372660	SCC430682660	SCC430902660	SCC431252660
CTD 14M 2800 C	200	2800	SCC430202800	SCC430372800	SCC430682800	SCC430902800	SCC431252800
CTD 14M 3136 C	224	3136	SCC430203136	SCC430373136	SCC430683136	SCC430903136	SCC431253136
CTD 14M 3304 C	236	3304	SCC430203304	SCC430373304	SCC430683304	SCC430903304	SCC431253304
CTD 14M 3500 C	250	3500	SCC430203500	SCC430373500	SCC430683500	SCC430903500	SCC431253500
CTD 14M 3850 C	275	3850	SCC430203850	SCC430373850	SCC430683850	SCC430903850	SCC431253850
CTD 14M 3920 C	280	3920	SCC430203920	SCC430373920	SCC430683920	SCC430903920	SCC431253920
CTD 14M 4410 C	315	4410	SCC430204410	SCC430374410	SCC430684410	SCC430904410	SCC431254410

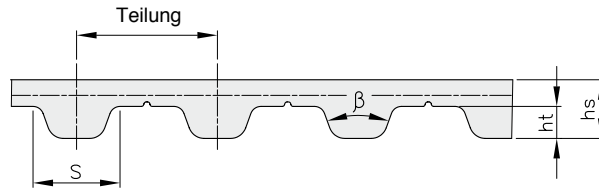

Werkstoff: Polyurethan mit Stahleinlagen

ABMESSUNGEN UND TOLERANZEN DER DICKE

Typ	Teilung mm	hs mm	Tol. mm	ht mm	S mm	β Grad
T 2,5	2,5	1,3	± 0,15	0,7	1,50	40
T 5	5	2,2	± 0,15	1,2	2,65	40
T 10	10	4,5	± 0,30	2,5	5,30	40

BREITENTOLERANZEN

Teilung mm	Breite mm	Toleranz mm
2,5	6	± 0,30
5	10	± 0,50
5	16	± 0,50
5	25	± 0,50
10	16	± 0,50
10	25	± 0,50
10	32	± 0,50
10	50	± 0,50

AUSWAHLTABELLE RIEMENTEILUNG

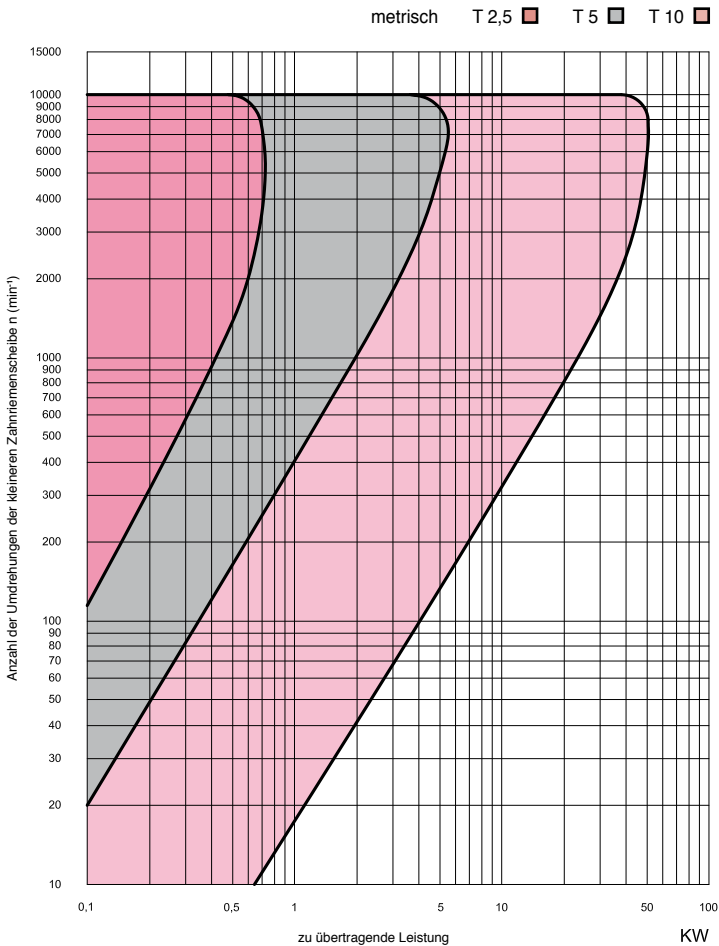

LÄNGENTOLERANZEN

Wirklänge mm	Toleranz mm
≤ 305	± 0,28
> 305–390	± 0,32
> 390–525	± 0,36
> 525–630	± 0,42
> 630–780	± 0,48
> 780–990	± 0,51
> 990–1250	± 0,64
> 1250–1560	± 0,76
> 1560–1960	± 0,88
> 1960–2250	± 1,04



ZAHNRIEMEN METRISCH, PROFIL „T“ – DIN 7721-1

T 2,5

Teilung 2,5 mm

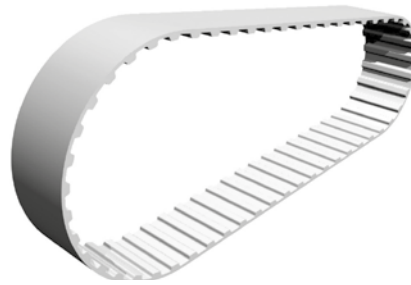

Werkstoff: Polyurethan

Beschreibung	Zähnezahl	Wirklänge mm	Artikelnr. T 2,5 Breite 6 mm
T 2,5 120	48	120,00	2260060120
T 2,5 145	58	145,00	2260060145
T 2,5 160	64	160,00	2260060160
T 2,5 177,5	71	177,50	2260060177
T 2,5 180	72	180,00	2260060180
T 2,5 200	80	200,00	2260060200
T 2,5 225	90	225,00	2260060225
T 2,5 230	92	230,00	2260060230
T 2,5 245	98	245,00	2260060245
T 2,5 250	100	250,00	2260060250
T 2,5 265	106	265,00	2260060265
T 2,5 285	114	285,00	2260060285
T 2,5 290	116	290,00	2260060290
T 2,5 305	122	305,00	2260060305
T 2,5 317	127	317,00	2260060317
T 2,5 330	132	330,00	2260060330
T 2,5 380	152	380,00	2260060380
T 2,5 395	158	395,00	2260060395
T 2,5 420	168	420,00	2260060420
T 2,5 480	192	480,00	2260060480
T 2,5 500	200	500,00	2260060500
T 2,5 540	216	540,00	2260060540
T 2,5 600	240	600,00	2260060600
T 2,5 650	260	650,00	2260060650
T 2,5 780	312	780,00	2260060780
T 2,5 915	366	915,00	2260060915
T 2,5 950	380	950,00	2260060950



ZAHNRIEMEN METRISCH, PROFIL „T“ – DIN 7721-1

T 5

Teilung 5 mm

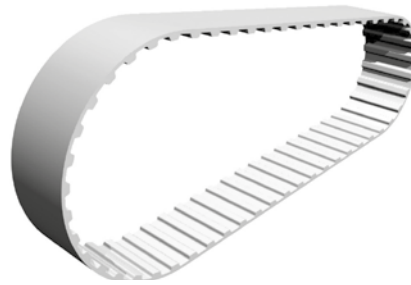

Werkstoff: Polyurethan

Beschreibung	Zähnezahl	Wirklänge mm	Artikelnr. T 5 Breite 10 mm	Artikelnr. T 5 Breite 16 mm	Artikelnr. T 5 Breite 25 mm
T 5 150	30	150,00	2270100150	2270160150	2270250150
T 5 165	33	165,00	2270100165	2270160165	2270250165
T 5 180	36	180,00	2270100180	2270160180	2270250180
T 5 185	37	185,00	2270100185	2270160185	2270250185
T 5 200	40	200,00	2270100200	2270160200	2270250200
T 5 210	42	210,00	2270100210	2270160210	2270250210
T 5 215	43	215,00	2270100215	2270160215	2270250215
T 5 220	44	220,00	2270100220	2270160220	2270250220
T 5 225	45	225,00	2270100225	2270160225	2270250225
T 5 245	49	245,00	2270100245	2270160245	2270250245
T 5 250	50	250,00	2270100250	2270160250	2270250250
T 5 255	51	255,00	2270100255	2270160255	2270250255
T 5 260	52	260,00	2270100260	2270160260	2270250260
T 5 270	54	270,00	2270100270	2270160270	2270250270
T 5 280	56	280,00	2270100280	2270160280	2270250280
T 5 295	59	295,00	2270100295	2270160295	2270250295
T 5 305	61	305,00	2270100305	2270160305	2270250305
T 5 330	66	330,00	2270100330	2270160330	2270250330
T 5 340	68	340,00	2270100340	2270160340	2270250340
T 5 350	70	350,00	2270100350	2270160350	2270250350
T 5 355	71	355,00	2270100355	2270160355	2270250355
T 5 365	73	365,00	2270100365	2270160365	2270250365
T 5 390	78	390,00	2270100390	2270160390	2270250390
T 5 400	80	400,00	2270100400	2270160400	2270250400
T 5 410	82	410,00	2270100410	2270160410	2270250410
T 5 420	84	420,00	2270100420	2270160420	2270250420
T 5 455	91	455,00	2270100455	2270160455	2270250455
T 5 460	92	460,00	2270100460	2270160460	2270250460
T 5 475	95	475,00	2270100475	2270160475	2270250475
T 5 480	96	480,00	2270100480	2270160480	2270250480
T 5 500	100	500,00	2270100500	2270160500	2270250500
T 5 505	101	505,00	2270100505	2270160505	2270250505
T 5 510	102	510,00	2270100510	2270160510	2270250510
T 5 525	105	525,00	2270100525	2270160525	2270250525
T 5 545	109	545,00	2270100545	2270160545	2270250545
T 5 550	110	550,00	2270100550	2270160550	2270250550
T 5 560	112	560,00	2270100560	2270160560	2270250560
T 5 575	115	575,00	2270100575	2270160575	2270250575
T 5 590	118	590,00	2270100590	2270160590	2270250590
T 5 610	122	610,00	2270100610	2270160610	2270250610
T 5 620	124	620,00	2270100620	2270160620	2270250620



ZAHNRIEMEN METRISCH, PROFIL „T“ – DIN 7721-1

T 5

Teilung 5 mm



Werkstoff: Polyurethan

Beschreibung	Zähnezahl	Wirklänge mm	Artikelnr. T 5 Breite 10 mm	Artikelnr. T 5 Breite 16 mm	Artikelnr. T 5 Breite 25 mm
T 5 630	126	630,00	2270100630	2270160630	2270250630
T 5 650	130	650,00	2270100650	2270160650	2270250650
T 5 660	132	660,00	2270100660	2270160660	2270250660
T 5 690	138	690,00	2270100690	2270160690	2270250690
T 5 700	140	700,00	2270100700	2270160700	2270250700
T 5 720	144	720,00	2270100720	2270160720	2270250720
T 5 750	150	750,00	2270100750	2270160750	2270250750
T 5 765	153	765,00	2270100765	2270160765	2270250765
T 5 780	156	780,00	2270100780	2270160780	2270250780
T 5 800	160	800,00	2270100800	2270160800	2270250800
T 5 815	163	815,00	2270100815	2270160815	2270250815
T 5 840	168	840,00	2270100840	2270160840	2270250840
T 5 900	180	900,00	2270100900	2270160900	2270250900
T 5 920	184	920,00	2270100920	2270160920	2270250920
T 5 940	188	940,00	2270100940	2270160940	2270250940
T 5 990	198	990,00	2270100990	2270160990	2270250990
T 5 1075	215	1075,00	2270101075	2270161075	2270251075
T 5 1100	220	1100,00	2270101100	2270161100	2270251100
T 5 1160	232	1160,00	2270101160	2270161160	2270251160
T 5 1215	243	1215,00	2270101215	2270161215	2270251215
T 5 1315	263	1315,00	2270101315	2270161315	2270251315
T 5 1380	276	1380,00	2270101380	2270161380	2270251380
T 5 1500	300	1500,00	2270101500	2270161500	2270251500



ZAHNRIEMEN METRISCH, PROFIL „T“ – DIN 7721-1

T 10

Teilung 10 mm

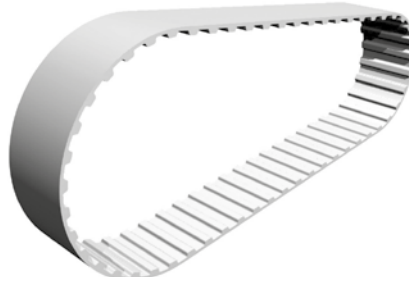

Werkstoff: Polyurethan

Beschreibung	Zähnezahl	Wirklänge mm	Artikelnr. T 10 Breite 16 mm	Artikelnr. T 10 Breite 25 mm	Artikelnr. T 10 Breite 32 mm	Artikelnr. T 10 Breite 50 mm
T 10 260	26	260,00	2280160260	2280250260	2280320260	2280500260
T 10 370	37	370,00	2280160370	2280250370	2280320370	2280500370
T 10 400	40	400,00	2280160400	2280250400	2280320400	2280500400
T 10 410	41	410,00	2280160410	2280250410	2280320410	2280500410
T 10 440	44	440,00	2280160440	2280250440	2280320440	2280500440
T 10 480	48	480,00	2280160480	2280250480	2280320480	2280500480
T 10 500	50	500,00	2280160500	2280250500	2280320500	2280500500
T 10 530	53	530,00	2280160530	2280250530	2280320530	2280500530
T 10 560	56	560,00	2280160560	2280250560	2280320560	2280500560
T 10 600	60	600,00	2280160600	2280250600	2280320600	2280500600
T 10 610	61	610,00	2280160610	2280250610	2280320610	2280500610
T 10 630	63	630,00	2280160630	2280250630	2280320630	2280500630
T 10 660	66	660,00	2280160660	2280250660	2280320660	2280500660
T 10 680	68	680,00	2280160680	2280250680	2280320680	2280500680
T 10 690	69	690,00	2280160690	2280250690	2280320690	2280500690
T 10 700	70	700,00	2280160700	2280250700	2280320700	2280500700
T 10 720	72	720,00	2280160720	2280250720	2280320720	2280500720
T 10 730	73	730,00	2280160730	2280250730	2280320730	2280500730
T 10 750	75	750,00	2280160750	2280250750	2280320750	2280500750
T 10 780	78	780,00	2280160780	2280250780	2280320780	2280500780
T 10 810	81	810,00	2280160810	2280250810	2280320810	2280500810
T 10 840	84	840,00	2280160840	2280250840	2280320840	2280500840
T 10 850	85	850,00	2280160850	2280250850	2280320850	2280500850
T 10 880	88	880,00	2280160880	2280250880	2280320880	2280500880
T 10 890	89	890,00	2280160890	2280250890	2280320890	2280500890
T 10 900	90	900,00	2280160900	2280250900	2280320900	2280500900
T 10 920	92	920,00	2280160920	2280250920	2280320920	2280500920
T 10 960	96	960,00	2280160960	2280250960	2280320960	2280500960
T 10 970	97	970,00	2280160970	2280250970	2280320970	2280500970
T 10 980	98	980,00	2280160980	2280250980	2280320980	2280500980
T 10 1010	101	1010,00	2280161010	2280251010	2280321010	2280501010
T 10 1080	108	1080,00	2280161080	2280251080	2280321080	2280501080
T 10 1110	111	1110,00	2280161110	2280251110	2280321110	2280501110
T 10 1140	114	1140,00	2280161140	2280251140	2280321140	2280501140
T 10 1150	115	1150,00	2280161150	2280251150	2280321150	2280501150
T 10 1210	121	1210,00	2280161210	2280251210	2280321210	2280501210
T 10 1240	124	1240,00	2280161240	2280251240	2280321240	2280501240
T 10 1250	125	1250,00	2280161250	2280251250	2280321250	2280501250
T 10 1300	130	1300,00	2280161300	2280251300	2280321300	2280501300
T 10 1320	132	1320,00	2280161320	2280251320	2280321320	2280501320
T 10 1350	135	1350,00	2280161350	2280251350	2280321350	2280501350



ZAHNRIEMEN METRISCH, PROFIL „T“ – DIN 7721-1

T 10

Teilung 10 mm



Werkstoff: Polyurethan

Beschreibung	Zähnezahl	Wirklänge mm	Artikelnr. T 10 Breite 16 mm	Artikelnr. T 10 Breite 25 mm	Artikelnr. T 10 Breite 32 mm	Artikelnr. T 10 Breite 50 mm
T 10 1390	139	1390,00	2280161390	2280251390	2280321390	2280501390
T 10 1400	140	1400,00	2280161400	2280251400	2280321400	2280501400
T 10 1420	142	1420,00	2280161420	2280251420	2280321420	2280501420
T 10 1460	146	1460,00	2280161460	2280251460	2280321460	2280501460
T 10 1500	150	1500,00	2280161500	2280251500	2280321500	2280501500
T 10 1560	156	1560,00	2280161560	2280251560	2280321560	2280501560
T 10 1610	161	1610,00	2280161610	2280251610	2280321610	2280501610
T 10 1750	175	1750,00	2280161750	2280251750	2280321750	2280501750
T 10 1780	178	1780,00	2280161780	2280251780	2280321780	2280501780
T 10 1880	188	1880,00	2280161880	2280251880	2280321880	2280501880
T 10 1960	196	1960,00	2280161960	2280251960	2280321960	2280501960
T 10 2250	225	2250,00	2280162250	2280252250	2280322250	2280502250

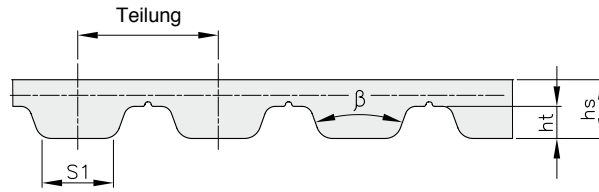

Werkstoff: Polyurethan mit Stahleinlagen

ABMESSUNGEN UND TOLERANZEN DER DICKE

Typ	Teilung mm	hs mm	Tol. mm	ht mm	S mm	β Grad
AT 5	5	2,7	± 0,15	1,2	2,5	50
AT 10	10	4,5	± 0,30	2,5	5,0	50

BREITENTOLERANZEN

Teilung mm	Breite mm	Toleranz mm
5	10	± 0,50
5	16	± 0,50
5	25	± 0,50
10	16	± 0,50
10	25	± 0,50
10	32	± 0,50
10	50	± 0,50

AUSWAHLTABELLE RIEMENTEILUNG

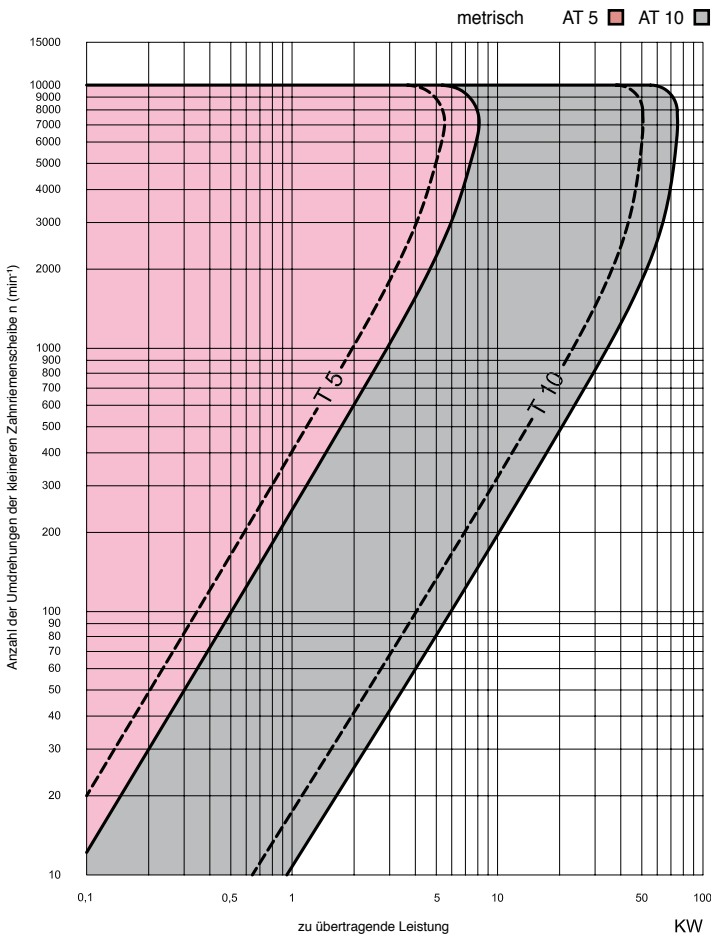

LÄNGENTOLERANZEN

Wirklänge mm	Toleranz mm
≤ 305	± 0,28
> 305–390	± 0,32
> 390–525	± 0,36
> 525–630	± 0,42
> 630–780	± 0,48
> 780–990	± 0,51
> 990–1250	± 0,64
> 1250–1560	± 0,76
> 1560–1960	± 0,88
> 1960–2250	± 1,04



ZAHNRIEMEN METRISCH, PROFIL „AT“

AT 5

Teilung 5 mm

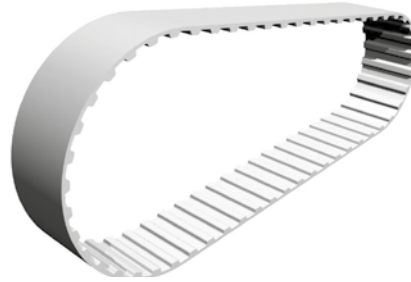

Werkstoff: Polyurethan

Beschreibung	Zähnezahl	Wirklänge mm	Artikelnr. AT 5 Breite 10 mm	Artikelnr. AT 5 Breite 16 mm	Artikelnr. AT 5 Breite 25 mm
AT 5 225	45	225,00	2600100225	2600160225	2600250225
AT 5 255	51	255,00	2600100255	2600160255	2600250255
AT 5 260	52	260,00	2600100260	2600160260	2600250260
AT 5 280	56	280,00	2600100280	2600160280	2600250280
AT 5 300	60	300,00	2600100300	2600160300	2600250300
AT 5 330	66	330,00	2600100330	2600160330	2600250330
AT 5 340	68	340,00	2600100340	2600160340	2600250340
AT 5 375	75	375,00	2600100375	2600160375	2600250375
AT 5 390	78	390,00	2600100390	2600160390	2600250390
AT 5 420	84	420,00	2600100420	2600160420	2600250420
AT 5 450	90	450,00	2600100450	2600160450	2600250450
AT 5 455	91	455,00	2600100455	2600160455	2600250455
AT 5 480	96	480,00	2600100480	2600160480	2600250480
AT 5 500	100	500,00	2600100500	2600160500	2600250500
AT 5 525	105	525,00	2600100525	2600160525	2600250525
AT 5 545	109	545,00	2600100545	2600160545	2600250545
AT 5 600	120	600,00	2600100600	2600160600	2600250600
AT 5 610	122	610,00	2600100610	2600160610	2600250610
AT 5 620	124	620,00	2600100620	2600160620	2600250620
AT 5 630	126	630,00	2600100630	2600160630	2600250630
AT 5 660	132	660,00	2600100660	2600160660	2600250660
AT 5 670	134	670,00	2600100670	2600160670	2600250670
AT 5 690	138	690,00	2600100690	2600160690	2600250690
AT 5 710	142	710,00	2600100710	2600160710	2600250710
AT 5 720	144	720,00	2600100720	2600160720	2600250720
AT 5 750	150	750,00	2600100750	2600160750	2600250750
AT 5 780	156	780,00	2600100780	2600160780	2600250780
AT 5 825	165	825,00	2600100825	2600160825	2600250825
AT 5 860	172	860,00	2600100860	2600160860	2600250860
AT 5 900	180	900,00	2600100900	2600160900	2600250900
AT 5 920	184	920,00	2600100920	2600160920	2600250920
AT 5 975	195	975,00	2600100975	2600160975	2600250975
AT 5 1050	210	1050,00	2600101050	2600161050	2600251050
AT 5 1125	225	1125,00	2600101125	2600161125	2600251125
AT 5 1230	246	1230,00	2600101230	2600161230	2600251230
AT 5 1500	300	1500,00	2600101500	2600161500	2600251500
AT 5 1750	350	1750,00	2600101750	2600161750	2600251750



ZAHNRIEMEN METRISCH, PROFIL „AT“

AT 10

Teilung 10 mm

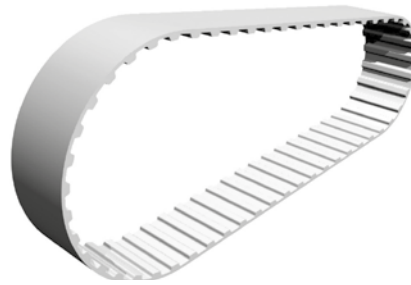

Werkstoff: Polyurethan

Beschreibung	Zähnezahl	Wirklänge mm	Artikelnr. AT 10 Breite 16 mm	Artikelnr. AT 10 Breite 25 mm	Artikelnr. AT 10 Breite 32 mm	Artikelnr. AT 10 Breite 50 mm
AT 10 440	44	440,00	2610160440	2610250440	2610320440	2610500440
AT 10 500	50	500,00	2610160500	2610250500	2610320500	2610500500
AT 10 560	56	560,00	2610160560	2610250560	2610320560	2610500560
AT 10 580	58	580,00	2610160580	2610250580	2610320580	2610500580
AT 10 600	60	600,00	2610160600	2610250600	2610320600	2610500600
AT 10 610	61	610,00	2610160610	2610250610	2610320610	2610500610
AT 10 660	66	660,00	2610160660	2610250660	2610320660	2610500660
AT 10 700	70	700,00	2610160700	2610250700	2610320700	2610500700
AT 10 730	73	730,00	2610160730	2610250730	2610320730	2610500730
AT 10 780	78	780,00	2610160780	2610250780	2610320780	2610500780
AT 10 800	80	800,00	2610160800	2610250800	2610320800	2610500800
AT 10 840	84	840,00	2610160840	2610250840	2610320840	2610500840
AT 10 880	88	880,00	2610160880	2610250880	2610320880	2610500880
AT 10 890	89	890,00	2610160890	2610250890	2610320890	2610500890
AT 10 920	92	920,00	2610160920	2610250920	2610320920	2610500920
AT 10 960	96	960,00	2610160960	2610250960	2610320960	2610500960
AT 10 980	98	980,00	2610160980	2610250980	2610320980	2610500980
AT 10 1000	100	1000,00	2610161000	2610251000	2610321000	2610501000
AT 10 1010	101	1010,00	2610161010	2610251010	2610321010	2610501010
AT 10 1050	105	1050,00	2610161050	2610251050	2610321050	2610501050
AT 10 1080	108	1080,00	2610161080	2610251080	2610321080	2610501080
AT 10 1100	110	1100,00	2610161100	2610251100	2610321100	2610501100
AT 10 1150	115	1150,00	2610161150	2610251150	2610321150	2610501150
AT 10 1210	121	1210,00	2610161210	2610251210	2610321210	2610501210
AT 10 1250	125	1250,00	2610161250	2610251250	2610321250	2610501250
AT 10 1280	128	1280,00	2610161280	2610251280	2610321280	2610501280
AT 10 1300	130	1300,00	2610161300	2610251300	2610321300	2610501300
AT 10 1320	132	1320,00	2610161320	2610251320	2610321320	2610501320
AT 10 1350	135	1350,00	2610161350	2610251350	2610321350	2610501350
AT 10 1400	140	1400,00	2610161400	2610251400	2610321400	2610501400
AT 10 1420	142	1420,00		2610251420		2610501420
AT 10 1480	148	1480,00	2610161480	2610251480	2610321480	2610501480
AT 10 1500	150	1500,00	2610161500	2610251500	2610321500	2610501500
AT 10 1600	160	1600,00	2610161600	2610251600	2610321600	2610501600
AT 10 1700	170	1700,00	2610161700	2610251700	2610321700	2610501700
AT 10 1800	180	1800,00	2610161800	2610251800	2610321800	2610501800
AT 10 1940	194	1940,00	2610161940	2610251940	2610321940	2610501940

Werkstoff: Polyurethan

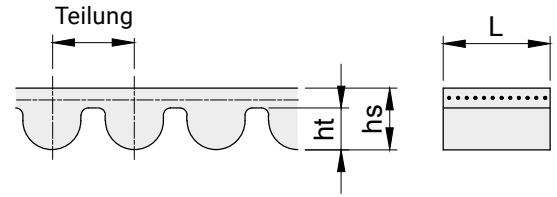
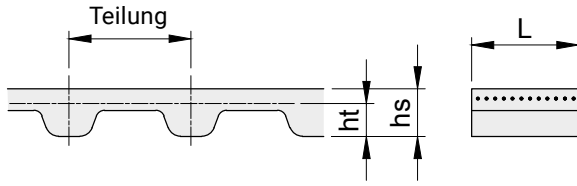

XL – L – H

Beschreibung	Artikel-nr.	Teilung mm	L mm	hs mm	ht mm	Zuglast bei max. N
XL 037	2900013037	5,08	9,5 ± 0,5	2,3 ± 0,30	1,27	290
L 050	2900014050	9,525	12,7 ± 0,5	3,6 ± 0,30	1,91	1270
L 075	2900014075	9,525	19,1 ± 0,5	3,6 ± 0,30	1,91	1960
L 100	2900014100	9,525	25,4 ± 0,5	3,6 ± 0,30	1,91	2760
L 150	2900014150	9,525	38,1 ± 0,5	3,6 ± 0,30	1,91	4140
H 075	2900015075	12,7	19,1 ± 0,5	4,3 ± 0,30	2,29	1960
H 100	2900015100	12,7	25,4 ± 0,5	4,3 ± 0,30	2,29	2760
H 150	2900015150	12,7	38,1 ± 0,5	4,3 ± 0,30	2,29	4140
H 200	2900015200	12,7	50,8 ± 0,5	4,3 ± 0,30	2,29	5640
H 300	2900015300	12,7	76,2 ± 0,5	4,3 ± 0,30	2,29	

5M – 8M – 14M

Beschreibung	Artikel-nr.	Teilung mm	L mm	hs mm	ht mm	Zuglast bei max. N
HTD 5M 9	2900041009	5	9 ± 0,5	3,6 ± 0,20	2,1	920
HTD 5M 15	2900041015	5	15 ± 0,5	3,6 ± 0,20	2,1	1500
HTD 5M 25	2900041025	5	25 ± 0,5	3,6 ± 0,20	2,1	2650
HTD 8M 20	2900042020	8	20 ± 0,5	5,6 ± 0,30	3,4	3190
HTD 8M 30	2900042030	8	30 ± 0,5	5,6 ± 0,30	3,4	4900
HTD 8M 50	2900042050	8	50 ± 0,5	5,6 ± 0,30	3,4	8580
HTD 8M 85	2900042085	8	85 ± 0,5	5,6 ± 0,30	3,4	14700
HTD 14M 40	2900043040	14	40 ± 1,0	10,0 ± 0,45	6,0	9120
HTD 14M 55	2900043055	14	55 ± 1,0	10,0 ± 0,45	6,0	12480
HTD 14M 85	2900043085	14	85 ± 1,0	10,0 ± 0,45	6,0	19680
HTD 14M 115	2900043115	14	115 ± 1,0	10,0 ± 0,45	6,0	26880
RPP 8M 20	2900044020	8	20 ± 1,0	5,6 ± 0,30	3,4	
RPP 8M 30	2900044030	8	30 ± 1,0	5,6 ± 0,30	3,4	

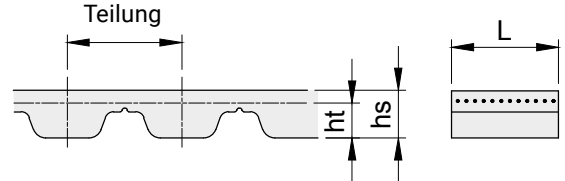
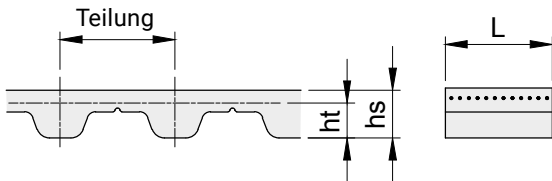

T5 – T10 – T20

Beschreibung	Artikel-nr.	Teilung mm	L mm	hs mm	ht mm	Zuglast bei max. N
T5 6	2900027006	5	6 ± 0,5	2,2 ± 0,15	1,2	190
T5 10	2900027010	5	10 ± 0,5	2,2 ± 0,15	1,2	320
T5 16	2900027016	5	16 ± 0,5	2,2 ± 0,15	1,2	540
T5 25	2900027025	5	25 ± 0,5	2,2 ± 0,15	1,2	900
T5 32	2900027032	5	32 ± 0,5	2,2 ± 0,15	1,2	1150
T5 50	2900027050	5	50 ± 0,5	2,2 ± 0,15	1,2	1860
T10 16	2900028016	10	16 ± 0,5	4,5 ± 0,30	2,5	1610
T10 25	2900028025	10	25 ± 0,5	4,5 ± 0,30	2,5	2650
T10 32	2900028032	10	32 ± 0,5	4,5 ± 0,30	2,5	3450
T10 50	2900028050	10	50 ± 0,5	4,5 ± 0,30	2,5	5520
T10 75	2900028075	10	75 ± 0,5	4,5 ± 0,30	2,5	8400
T10 100	2900028100	10	100 ± 0,5	4,5 ± 0,30	2,5	11270
T20 25	2900029025	20	25 ± 1,0	8,0 ± 0,45	5,0	4170
T20 32	2900029032	20	32 ± 1,0	8,0 ± 0,45	5,0	5390
T20 50	2900029050	20	50 ± 1,0	8,0 ± 0,45	5,0	8580
T20 75	2900029075	20	75 ± 1,0	8,0 ± 0,45	5,0	12990
T20 100	2900029100	20	100 ± 1,0	8,0 ± 0,45	5,0	17400

AT5 – AT10 – AT20

Beschreibung	Artikel-nr.	Teilung mm	L mm	hs mm	ht mm	Zuglast bei max. N
AT 5 10	2900060010	5	10 ± 0,5	2,7 ± 0,20	1,2	640
AT 5 16	2900060016	5	16 ± 0,5	2,7 ± 0,20	1,2	1120
AT 5 25	2900060025	5	25 ± 0,5	2,7 ± 0,20	1,2	1840
AT 5 32	2900060032	5	32 ± 0,5	2,7 ± 0,20	1,2	2400
AT 10 16	2900061016	10	16 ± 0,5	4,5 ± 0,30	2,5	2450
AT 10 25	2900061025	10	25 ± 0,5	4,5 ± 0,30	2,5	4170
AT 10 32	2900061032	10	32 ± 0,5	4,5 ± 0,30	2,5	5390
AT 10 50	2900061050	10	50 ± 0,5	4,5 ± 0,30	2,5	8580
AT 20 25	2900062025	20	25 ± 1,0	8,0 ± 0,45	5,0	5280
AT 20 32	2900062032	20	32 ± 1,0	8,0 ± 0,45	5,0	7200
AT 20 50	2900062050	20	50 ± 1,0	8,0 ± 0,45	5,0	11520
AT 20 75	2900062075	20	75 ± 1,0	8,0 ± 0,45	5,0	17280
AT 20 100	2900062100	20	100 ± 1,0	8,0 ± 0,45	5,0	23520

Die Klemmplatten werden zur Befestigung der Riemen-Enden eingesetzt.

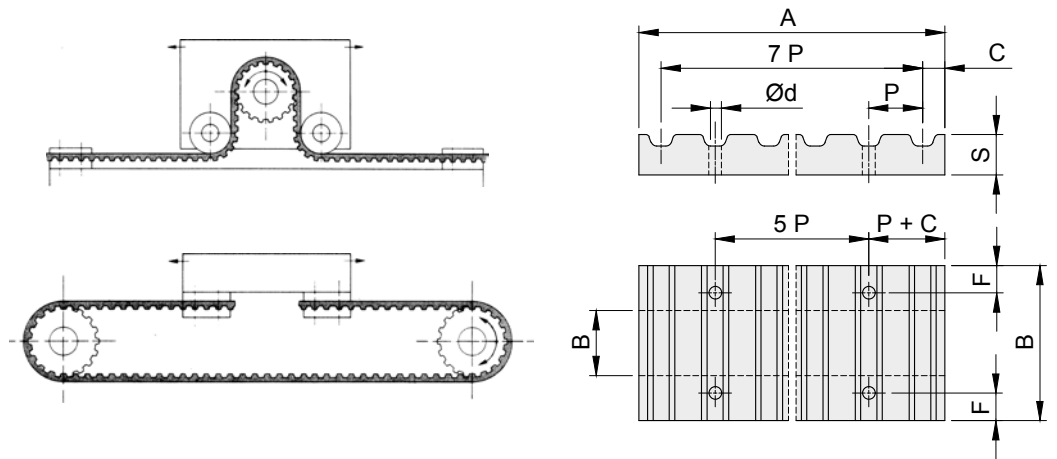

Werkstoff: Aluminium

Beschreibung	Artikelnr.	Teilung	A	B	Ø d	F	C	S	L	kg
XL 025	5010013025	5,08	42,5	25,5	5,5	6	3,5	8	6,4	0,02
XL 037	5010013037	5,08	42,5	28,5	5,5	6	3,5	8	9,5	0,02
L 050	5010014050	9,525	76,6	39	9	8	5	15	12,7	0,10
L 075	5010014075	9,525	76,6	45	9	8	5	15	19,1	0,12
L 100	5010014100	9,525	76,6	51,5	9	8	5	15	25,4	0,14
H 050	5010015050	12,70	106,9	45	11	10	9	22	12,7	0,25
H 075	5010015075	12,70	106,9	51	11	10	9	22	19,1	0,28
H 100	5010015100	12,70	106,9	57,5	11	10	9	22	25,4	0,32
5M 9	5010041009	5	41,5	28	5,5	6	3,2	8	9	0,02
5M 15	5010041015	5	41,5	34	5,5	6	3,2	8	15	0,03
5M 25	5010041025	5	41,5	44	5,5	6	3,2	8	25	0,04
8M 20	5010042020	8	66	45	9	8	5	15	20	0,10
8M 30	5010042030	8	66	55	9	8	5	15	30	0,12
8M 50	5010042050	8	66	75	9	8	5	15	50	0,17
8M 85	5010042085	8	66	110	9	8	5	15	85	0,25
14M 40	5010043040	14	116	71	11	10	9	22	40	0,40
14M 55	5010043055	14	116	86	11	10	9	22	55	0,50
14M 85	5010043085	14	116	116	11	10	9	22	85	0,68
14M 115	5010043115	14	116	146	11	10	9	22	115	0,85
14M 170	5010043170	14	116	201	11	10	9	22	170	1,14
T 5 10	5010027010	5	41,8	29	5,5	6	3,4	8	10	0,02
T 5 16	5010027016	5	41,8	35	5,5	6	3,4	8	16	0,03
T 5 25	5010027025	5	41,8	44	5,5	6	3,4	8	25	0,04
T10 16	5010028016	10	80	41	9	8	5	15	16	0,11
T10 25	5010028025	10	80	50	9	8	5	15	25	0,14
T10 32	5010028032	10	80	57	9	8	5	15	32	0,16
T10 50	5010028050	10	80	75	9	8	5	15	50	0,22
AT5 10	5010060010	5	41,8	29	5,5	6	3,4	8	10	0,02
AT5 16	5010060016	5	41,8	35	5,5	6	3,4	8	16	0,03
AT5 25	5010060025	5	41,8	44	5,5	6	3,4	8	25	0,04
AT10 16	5010061016	10	80	41	9	8	5	15	16	0,11
AT10 25	5010061025	10	80	50	9	8	5	15	25	0,14
AT10 32	5010061032	10	80	57	9	8	5	15	32	0,16
AT10 50	5010061050	10	80	75	9	8	5	15	50	0,22